



ABB PGC5000 Series technology review

# Solutions from the process sample tap to measurement delivery

# Introduction

The Hydrocarbon Processing Industry (HPI) converts gas, coal, and petroleum feedstocks into energy, petrochemicals, and a broad array of chemical products for industry, agriculture, and consumers. Processing of naturally occurring materials into manmade products is a multi-step continuous process designed to produce a consistent manufactured result. Safety, quality, and profitability require that the products are produced in a reliable and repeatable fashion. Producing the product **Right the First Time** is a continual challenge due to the variation in naturally occurring raw materials.

Process analytics provides a window into the chemical production process and the results are a direct measurement of the chemical parameters to optimize and enhance the standard physical data of pressure, temperature, flow, and viscosity for the process unit. Process analysis starts with the requirement to consistently present the sample to the analyzer for analysis and ends with the successful delivery of valid analysis data to the Distributed Control System (DCS) or other monitoring systems. The technologies used for Sample Handling, Conditioning, Analysis, and Reporting continue to evolve and improve in reliability. Reliability is a key feature for process analytics and it is directly related to the robustness of the Sample Handling Systems (SHS), Process Analyzers, and Communication Links.



# Sample handling systems

Seventy to ninety percent of all process analyzer issues are caused by sample handling systems. Historically, sample handling systems have been assembled from discrete components to meet the sampling requirements of the process stream's chemistry and the analytical device. Lack of consistency on SHS engineering design has led to increased costs at the majority of installations due to training (each SHS having a different design), spare part inventories (each SHS having unique components), and reliability in designs (lack of standardization).

The Generation 1 modular sample handling systems, based upon the ANSI/ISA SP76.00.02-2002 standard, introduce a standardization that has been missing and can significantly reduce life cycle costs for these installations. Generation 2 devices are now available that allow the sample handling systems to become "Smart" and monitor pressure, temperature, and flows through web browsers and analyzer interfaces.

Modular sample handling systems (SHS) are based upon the ANSI/ISA SP76.00.02-2002 standard (International Standard IEC 62339-1 published First Edition 2006-12; reference IEC 62339-1:2006[E]) which specifies a consistent mechanical layout of the SHS components. End users are presented with a wide array of interchangeable substrates (mounting templates) and components (valves, metering devices, flow control) from all SHS component suppliers that comply with this design standard.

The modular SHS is built from base modules into three standard offerings: One stream, Two streams and Three streams.

**The Stream Switching module** includes a pneumatic three way stream switching valve per stream (process streams, calibration streams, and validation streams), a needle valve

for analyzer sample flow adjustment, a pneumatic sample shut off valve, and an analyzer stream polishing filter.

**The Atmospheric Reference Vent (ARV) module** includes a pneumatic three way stream to atmospheric vent switching valve and analyzer sample flow return indicator. Using the ARV module with the stream switching module produces the necessary function to block a sample and reference it to atmospheric pressure prior to sample injection. This is commonly referred to as a Block and Bleed valve.

**The Sample Bypass or Fast Loop module** includes a manual fast sample loop shut off valve, a mechanical pressure indicator, a sample bypass filter, a needle valve for fast loop flow adjustment, and a fast loop flow indicator.

The PGC5000 allows Generation 2 CANbus devices working on the protocol standard, CANopen, and hardware draft IS CAN standard, CiA-103, to communicate through the analyzer. Pressure, temperature and flows are read through the analyzer's setup screens and alarm limits can be set on all measurement modules. The PGC5000 Remote User Interface (RUI) now allows for remote monitoring of the analyzer and its sampling system.

## ABB SMART™ module

The ABB SMART module has the connection to the PGC5000 Master Controller for control and data collection. With this device, the software has the following features: Digital SHS Valve control with Alarm Status; Sample Temperature, Sample Pressure, and Sample Flow Alarm Status; Filter Differential Pressure Alarm Status; and, Analog Inputs. Using the ABB SMART module, all alarm indicators from the SHS are available at the master controller for OPC and/or MODBUS data to validate analyses from the PGC.



ABB SMART module



SMART sample handling system

# Process analyzers

Process measurements can be accomplished with a number of different technologies depending on the requirements. Process gas chromatography is the most powerful analytical method for these measurements. The key principles of this analytical method are **Separation** and **Measurement**. These two features greatly outweigh other process analytical techniques to guarantee the quality and accuracy of each measured component in the analysis. Separation and Measurement is the only way to guarantee there are no interferences with each

measurement. The PGC can be optimized for each application with a wide variety of hardware options, including columns, detectors, and valves, to provide the lowest detection limit and best repeatability possible for each measured component. An additional benefit using this technique is the large number of components which can be measured simultaneously without interference. All of these features and benefits make the process gas chromatograph the most flexible and capable process analytical technique available.

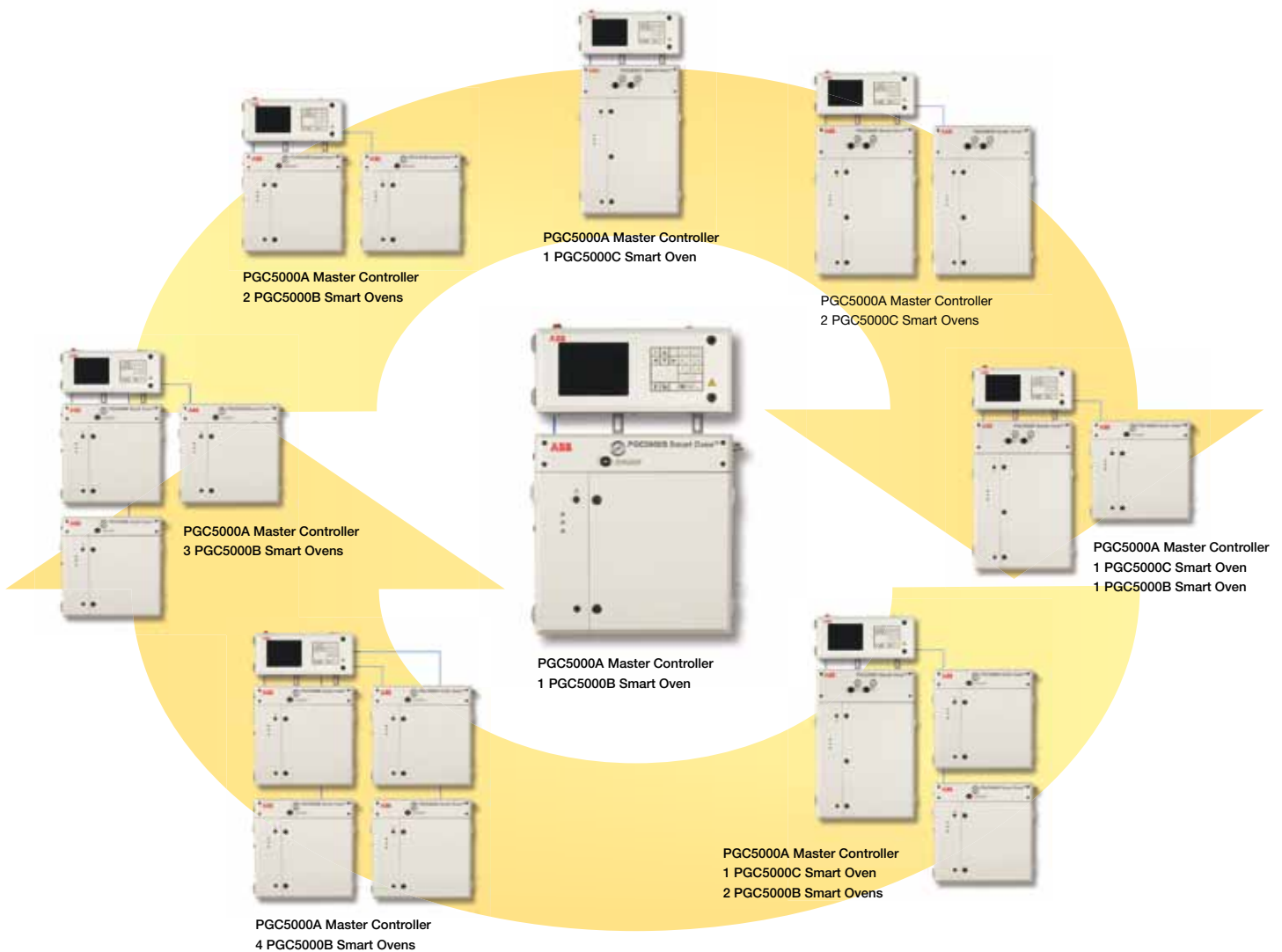

# The PGC5000 series

## Applications made simple

Multiple PGC5000 Smart Ovens™ complete any analytical project; typical applications can be designed with a simple product resulting in highly reliable, uncomplicated applications.

- Multiple stream analyses are grouped together, running simultaneously in parallel using multiple simple ovens for routine applications.
- Troubleshooting problems or failures in each stream's analysis becomes more logical and easier to identify using multiple ovens.
- Alarms and chromatographic problems are isolated and the application sequences can be viewed independently to identify the source of failure.
- Multiple isothermal temperature zones allow the application engineer to select the best column(s) for separating hydrocarbon groups with a wide boiling point range.

## Complex applications made reliable

Complex applications requiring multiple valves and detectors are designed with independent analysis sequences using the larger PGC5000 Smart Oven™. This yields measurement sequences which are easier to understand and maintain for greater long term reliability. More analytical valves, more digital pressure zones, and multiple detectors can be applied to support the most complex application.

- Breaking a complex application into one or more parallel and/or serial measurement sequences makes them easier to understand and maintain the complete analysis.
- Alarms are isolated to each sequence, stream and/or component to identify the source of failure.
- Simultaneous sequences can be used to produce shorter analysis cycle times.

## Space and utilities cost reduction

The more flexible design of PGC5000 series with its distributed Smart Ovens™ architecture changes the analyzer density in shelter design. A higher density of analyzers allows for the reduction in shelter footprint saving on space, materials and utilities with greater application capacity. In existing analyzer shelters, the multiple oven designs and distributed architecture can increase the present analytical capacity allowing for expansion of process measurements without a new shelter.

## System benefits

- Multiple oven configurations can be designed for parallel and simultaneous chromatography offering the optimal application solution
- Process monitor and control configurations
- Division 2 / Zone 2 by design base certification reduces cost
- Complete line of detector and valve types to design and produce the best possible analytical measurement
- Wide-range of I/O solutions for complete integration

## Unlimited application flexibility

The PGC5000 Series can be designed with a single Master Controller and up to four Smart Ovens™ via intrinsically safe fiber optic communication. The PGC5000A Master Controller can be configured in the following:

1. One to four PGC5000B Smart Ovens™
2. One to two PGC5000C Smart Ovens™
3. One PGC5000C and up to 2 PGC5000B Smart Ovens™

Each of these configurations have unlimited simultaneous and parallel chromatography options for all process applications depending on the type of safety, process control, process monitoring, or environmental applications and installation requirements. Application flexibility, optimization, and reliability are greatly improved using the PGC5000 Series Multiple Oven design.

# The PGC5000 series Master Controller

## The PGC5000 series Master Controller

The Model PGC5000A Master Controller is the industry standard for ease of operation. The Graphically Driven HMI with standard keypad and mouse touch pad makes developing, changing, or editing analyses easy without traditional programming skills. Simple Point and Click and Drag and Drop functions are all that is required to access and change any of the analyzer functions.

- Highly graphical, true color 26.42 cm (10.4 in) SVGA LCD display
- Universal keypad with mouse touch pad
- Redundant Ethernet NIC's
- Standard USB ports for analyzer configuration backup, software version upgrading, and file transfer
- PC based Remote User Interface (RUI) capability
- Language Translation

All of the major analyzer functions are grouped on tabs making it easy to navigate and access the information needed.



PGC5000A Master Controller, PGC5000B and PGC5000C Smart Ovens

# Localization, safety, certification, sustainability

## Localization

The Help Tab provides translation and direct access to support globalization of the PGC5000:

The analyzer has been translated into 10 regional languages:

- English, French, German, Italian, Russian, Spanish, Japanese, Chinese, Korean, and Portuguese

Support for localization maximizes user understanding and increases operational and plant safety.

Local requirements for hazardous area certifications have been met by multiple standards.

- Zone 2 and Division 2 by design
- Zone 1 and Division 1
- RoHS compliance
- IEC, NEC, CSA, PCEC, GOST, KGS, TIIS (pending)

## Ease of use

The Home Tab enables a user can see real time status of the analyzer system's health and external communications. View real time chromatograms and multiple chromatogram overlays from up to four ovens and twelve parallel detectors.

The Setup Tab views the factory set parameters such as flow configuration, carrier pressure, oven temperature, and valve types. The programming guarantees access to the original factory parameters and greatly simplifies startup. Also, view the analyzer hardware, software, and firmware part numbers and descriptions for all major parts configured for a specific analyzer.

## Informative

The Help Tab provides direct access to step by step procedures for all major components along with detailed instruction on the operational software. Real time help is available at your finger tip.

The Status Tab allows viewing and configuration of all indicators for up to four ovens. This comprehensive Condition Monitoring System allows a user to select and configure indicators for a stream, an analysis, and/or a component(s), your choice.

The Analysis Tab provides an interactive graphical editor which enables the user to Drag and Drop time coded functions for optimizing and fine tuning application methods.

The Schedule Tab updates and changes the stream timing and analysis order with simple Point and Click. There are three separate configuration Subtabs, Step, Time-of-Day (TOD), and Demand, that allow for ad hoc changes to the active analyses to be executed when needed. All changes are updated in the Queue window where the streams are color coded according to their running status. These changes are easy to execute and are not disruptive or time consuming.

## Configurable

**What about needing to add two components together or doing a heat value calculation of the hydrocarbon stream?**

The Programming Tab uses a very simple and straightforward scripting language to write programs for the most complex calculation requirement. Additionally, the flexibility of the scripting software allows a user to program basic Programmable Logic Controller (PLC) functions directly into the analyzer system; thereby, eliminating the need for complex and expensive PLC's to configure and maintain.

## Sustainable

**What if you add another detector or an additional oven?**

Along with the new detector or oven, you will receive the updated system configuration which can be conveniently downloaded across the analyzer network or using one of available USB ports a user can insert a standard USB drive with the new configuration and update the new configuration. It's that easy!

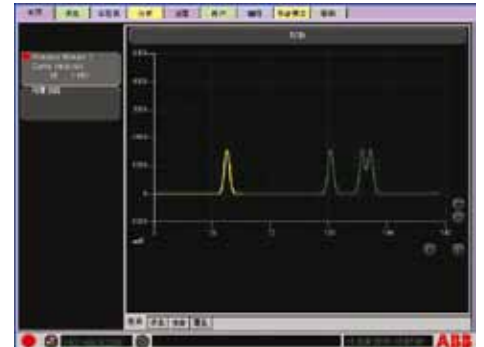
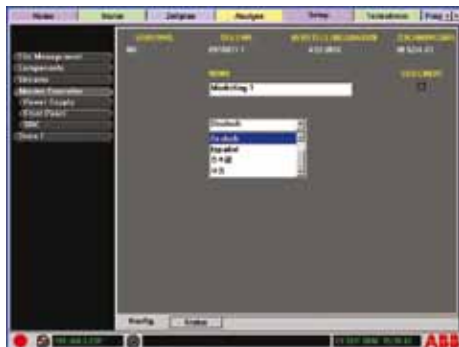

Screen examples

# The PGC5000 series Smart Oven™ technology

When making complex applications simple or multiplexing numerous stream samples, the PGC5000 Smart Oven™ technology meets all the applications requirements. Each Smart Oven™ is comprised of three sections; the Analytical Flow Control section, the Analytical Oven section, and the Analytical Oven Electronic section. All sections have front access while the Analytical Oven electrical section also has an additional side access for easy maintenance and service for all critical analytical and electrical components. All analytical flow inlet and outlet connections are located on the right side of the analyzer oven. This allows for mounting multiple ovens in a vertical arrangement and keeps the piping layout simple and accessible.

Each Smart Oven™ oven has an independent Oven Control (OC) board located in the PGC5000A Master Controller for independent application control. Digital communication are used between the oven controller and each peripheral component, such as the Digital Temperature Controller (DTC), the Electronic Pressure Control (EPC), and Detector (DET) modules. This architecture enhances all hardware component life cycle planning and makes any future engineering enhancements and design changes transparent to the end user.

## Analytical flow control

Electronic Pressure Control (EPC) module is standard and supports up to five pressure zones with the PGC5000B and up to ten pressure zones with the PGC5000C which can be set directly via the Master Controller keypad or remotely via a network PC using the Remote User Interface (RUI) software.

- Improves chromatography by providing better resolution and exceptional retention time consistency improving analyzer stability

- Digital control reproduces pressure settings far more precisely than mechanical pressure regulators
- Necessary for valveless applications
- Ambient temperature, carrier supply, and barometric pressure effects are eliminated by using a temperature controlled housing

## Analytical oven

The PGC5000 Smart Ovens™ incorporate an efficient layout ensuring easy access to all the critical components in the oven. The Analytical Oven section houses analytical valves for vapor and liquid applications, detectors, catalytic air purifier/methanizer, air bath heater, and analytical columns.

The PGC5000B Smart Oven™ technology supports applications which require:

- Single detector – sTCD, mTCD, FID, DID and FPD
- Up to three analytical valves
- A single PGC5000A Controller can support up to four PGC5000B Smart Ovens™
- The highest level of reliability – process critical measurements

The PGC5000C Smart Oven™ technology supports applications which require:

- Multiple detectors – sTCD, mTCD, FID, DID and FPD
- Up to six analytical valves
- A single PGC5000A Controller can support up to two PGC5000C Smart Ovens™
- Multiplexing multiple streams' analyses in a single analytical oven
- The highest level of application complexity



### Oven electronics

The Analytical Oven Electronic Section houses all the electronics for digital signal processing of detector signals, temperature control, pressure control, solenoid relay control, heater control, digital inputs and purge and common alarm input.

### Signal processing

The ultimate goal of the PGC is to provide the user with a repeatable and accurate determination of component concentrations. The analyzer incorporates a Min – Max peak detection algorithm that provides more consistency and repeatability for all component measurements because baseline detector noise calculations and peak calculations are both used in the integration. This method includes windows for crest time, start and stops integration, and start and stop baseline correction which provides greater reliability to identify the

component to be measured. The PGC5000A Master Controller with its graphical user interface makes setting and adjusting these parameters for each peak simple and straight forward.

### Digital temperature and pressure control

Digital Temperature Control is provided for the Analytical Oven, the Catalytic Air Purifier/Methanizer, and the Liquid Sample valve. As with digital pressure control, digital temperature control reproduces temperature settings far more precisely than analog temperature control. Full visibility of the temperature settings and the ability to change these settings are accomplished at the PGC5000A Master Controller or Network PC. The digital pressure control PC Board provides digital control of the EPC Module located in the Analytical Flow section. Its benefits are the same as described for the digital temperature control above.

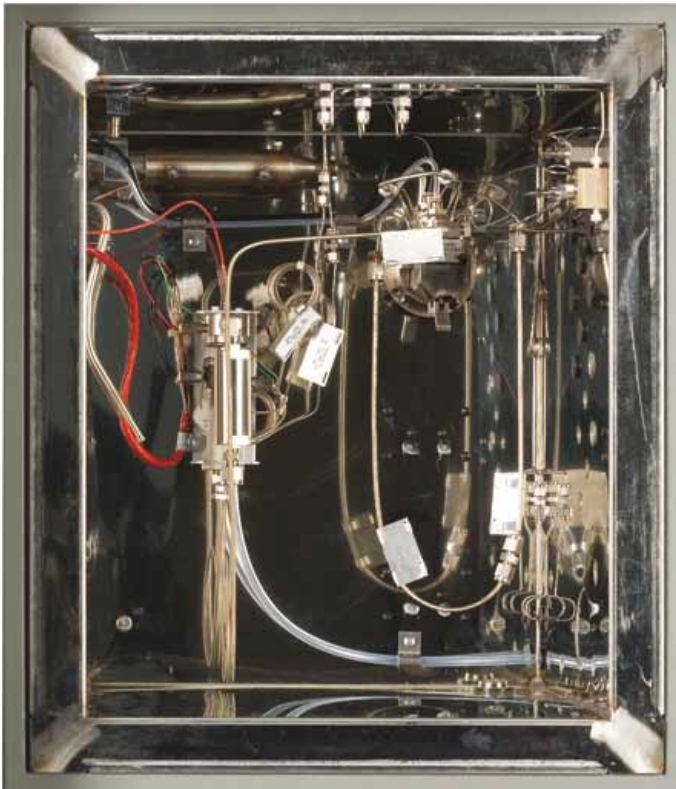

Oven interior

# Analytical valves

## Analytical valves

Analytical Valves in an online process GC are critical to reliability and performance. Ensuring a precise sample inject and directing the analytical flow through the proper flow path for each analysis are critical for repeatable and consistent results.

Analytical valves need to be designed so that the materials in contact with the sample are compatible and replaceable parts are easy to access and remove. The PGC5000 Series comes with multiple analytical valve options to meet the simple or most challenging application requirements.

### Sliding Plate Valve: model M2CP

The Sliding Plate Valve accommodates packed or capillary columns. Design includes automatic wear compensation and slider tension loading. This valve is the simplest and easiest analytical valve to maintain in the industry. It is the perfect analytical valve to keep your maintenance costs to a minimum.

- Accommodates packed, micropacked, or capillary columns
- Actuation pressure 276 kPa (40 PSI)
- Sample pressures up to 1,034 kPa (150 PSI)
- Temperatures up to 180° C (356° F)
- Simplest and easiest analytical valve to maintain in the industry
- Design includes automatic wear compensation and slider tension loading
- Keeps maintenance cost to a minimum

### Diaphragm valve

The diaphragm valve also accommodates packed or capillary columns. This valve is ideal to use for more complex analysis with critical valve timings.

- Accommodates packed, micropacked, or capillary columns
- Actuation pressure 345 kPa (50 PSI)
- Sample pressures up to 2,068 kPa (300 PSI)
- Temperatures up to 200° C (362° F)
- Ideal for complex analysis with critical valve timings

### Micro liquid sample inject valve: model 791

The field proven liquid sample valve, with wear compensating seals, is a one piece design with vaporizer and metal surface deactivation to yield longer life.

- One piece design with vaporizer and metal surface deactivation to yield longer life
- Sample pressures up to 2,999 kPa (435 PSI)
- Temperatures up to 200°C (392° F)
- Mechanical Mounting Plate grounds the connection for

- the GC sample inlet/outlet to a fixed position
- Isolates excessive loads on the LSV sample chamber eliminating premature wearing of the seals and damage to the stem

## Analytical columns

Analytical columns may consist of packed columns, capillary columns, or micropacked columns based on the application engineering requirements for a given application. ABB Analytical has been producing packed columns for 50 years and has developed processes over this time frame that will ensure the best and most consistent performance of its columns.



Continuous performance (CP) sliding plate valve



Model 791 - Micro sample liquid inject valve

# Analytical detectors

## Analytical detectors

Chromatography is a measurement technology based upon separation and detection of components in a complex mixture. Detector technology is one of the key success factors in the application of this technology. The ability to detect ppm or ppb levels of constituents with high levels repeatability is critical to the use of analytical measurements for process monitoring and control.

### Single port Thermal Conductivity (sTCD) Detector

The filament or thermistor style single port TC detector is suited for analytical measurements from high ppm to percent ranges, depending on analytical hardware configuration and application chemistry. It may be applied to measurements below 100 ppm.

### Multiport Thermal Conductivity (mTCD) Detector

Multiport TC detector is an EXd (explosion proof) design that is very compact but allows convenient maintenance. The measuring cell has four elements which may be filament or thermistor style. It may be configured for dual TC detector applications using two measure and two reference paths.

### Flame Ionization Detector (FID)

The FID is a small compact design that provides extreme sensitivity for the ppm/ppb hydrocarbon measurements. The optional Catalytic Air Purifier/Methanizer typically is used with the FID to purify the burner air supply and make low ppm level measurements of carbon monoxide and carbon dioxide.

### Flame Photometric Detector (FPD)

The FPD is a small compact design that provides extreme sensitivity for the ppm/ppb sulfur measurements. Sulfur addition module yields 200 times more sensitivity for total sulfur measurements. Thermoelectrically cooling the Photomultiplier Tube (PMT) reduces thermal noise and extends the PMT life. The auto ignition circuit that is closely coupled to burner chamber, PMT and optical filter to improved performance and levels of detection.

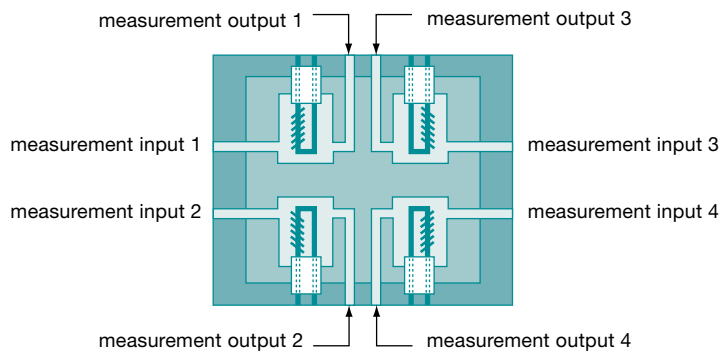

Multiport - TCD

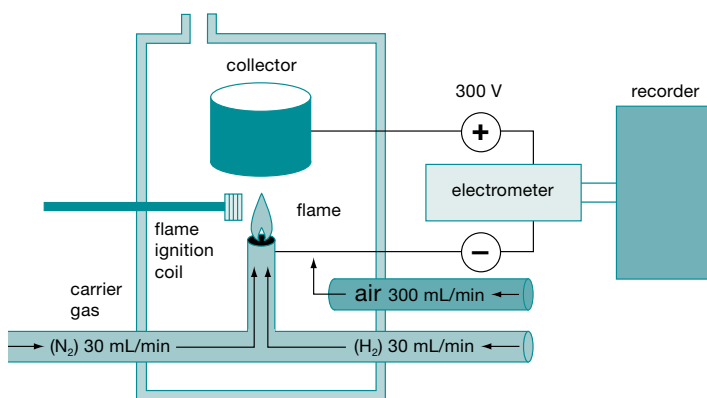

FID

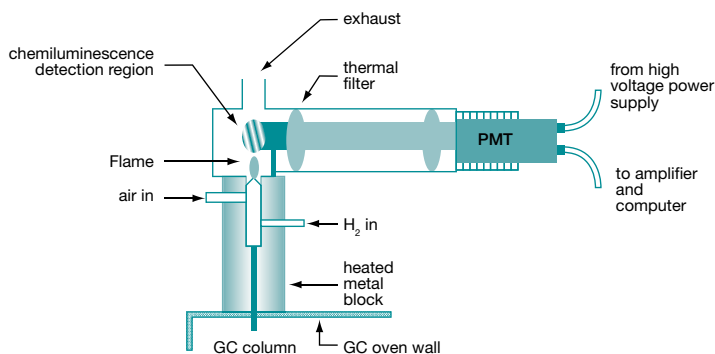

FPD

# Contact us

## Connectivity

To complete the analysis cycle, data must be delivered to the process control and/or monitoring systems. Analyzers provide results to the DCS, maintenance terminals, PLC, and logging systems to complete the process analysis. Intrinsically safe, fiber optic options are available for all communication protocols.

Redundancy is available to ensure 100% data transmission integrity to the process control and/or monitoring system. Industry standard Ethernet connections support Remote User Interfaces, OPC data, and MODBUS TCP/IP data. Industry standard serial connections support MODBUS RTU data.

## From the analyzer

Base level communications are available from every analyzer. Basic functions support analyzer control and analysis results. Examples include: remote stream selection, third party sensors, and event triggers.

## Analyzer inputs-outputs

Analog modules:

- Inputs to read third party device values
- Outputs for measured and calculated components

Digital modules:

- Inputs for remote control of analyzer functions and customer supplied sensors for data validation
- Outputs for alarms and external valve control

## From the network

For process-wide and plant-wide installations the analyzer connects using Industry standard Ethernet protocols. The ABB VistaNET™ single wire solution enables seamless connectivity to existing Ethernet based systems and integration of a wide range of process analyzer technologies and provides data interchange between analyzers, PCs, DCS, software platforms, across LANs, and higher-level processes.

## Daily operation

- Remote access and control of analyzer functions
- Analysis reporting
- Data analysis for maintenance, troubleshooting, and optimization of assets

## Data distribution

- Plant process unit control through OPC and MODBUS
- Monitor operations specific to process control and higher level processes

## Alarms, events and reporting

- Printing services
- Data storage, trending and analysis

## ABB Inc.

843 N. Jefferson Street  
Lewisburg, WV 24901  
USA  
Phone: 304-647-4358  
Fax: 304-645-4236  
E-Mail: [Analyzeit@us.abb.com](mailto:Analyzeit@us.abb.com)

[www.abb.com/analytical](http://www.abb.com/analytical)

## Note:

We reserve the right to make technical changes or modify the contents of this document without prior notice. With regard to purchase orders, the agreed particulars shall prevail. ABB does not accept any responsibility whatsoever for potential errors or possible lack of information in this document.

We reserve all rights in this document and in the subject matter and illustrations contained therein. Any reproduction, disclosure to third parties or utilization of its contents - in whole or in part - is forbidden without prior written consent of ABB.

© Copyright 2010 ABB.  
All rights reserved.