

产品特性

- 零反向恢复电流
- 零正向恢复电压
- 开关特性不受温度影响
- 适合高温工作
- 适合高频工作

V_{RRM}	650V
$I_F (T_C = 144^\circ\text{C})$	20A
Q_c	52nC

产品优点

- 单极性器件
- 极大降低开关损耗
- 并联使用无热崩溃
- 降低散热片的要求

应用领域

- 开关电源(SMPS), 功率因数校正(PFC)
- 电动汽车/混合动力汽车
- 电机驱动器
- 光伏, 不间断电源
- 风力发电, 机车牵引



TO-247AC

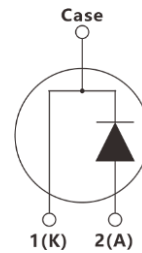

内部电路



G = GPT
3 = 第三代
S = 碳化硅肖特基二极管
065 = 电压等级 650V
20 = 电流等级 20A
P = TO-247AC
DDDDDD = 追溯码



最大值 ($T_j = 25^\circ\text{C}$, 有特殊说明除外)

参数	符号	数值	单位
反向重复峰值电压	V_{RRM}	650	V
反向浪涌峰值电压	V_{RSM}	650	V
正向连续电流 $T_c = 25^\circ\text{C}$ $T_c = 135^\circ\text{C}$ $T_c = 144^\circ\text{C}$	I_F	50.4 23.4 20	A
重复正向浪涌峰值电流 $T_c = 25^\circ\text{C}$, $t_p = 10\text{ms}$, 正弦半波	I_{FRM}	100	A
非重复正向浪涌峰值电流 $T_c = 25^\circ\text{C}$, $t_p = 10\text{ms}$, 正弦半波	I_{FSM}	160	A
i^2t 值 $T_c = 25^\circ\text{C}$, $t_p = 10\text{ms}$, 正弦半波	$\int i^2 dt$	128	A^2s
耗散功率 $T_c = 25^\circ\text{C}$ $T_c = 110^\circ\text{C}$	P_{tot}	179 77	W
工作温度	T_j	-55 to +175	$^\circ\text{C}$
存储温度	T_{stg}	-55 to +175	$^\circ\text{C}$
安装力矩, M3 螺丝	M	1	Nm



电特性 ($T_J = 25^\circ\text{C}$, 有特殊说明除外)

参数	符号	测试条件	数值			单位
			最小值	典型值	最大值	
直流阻断电压	V_{DC}		650	-	-	V
正向电压	V_F	$I_F = 20\text{A}$ $T_J = 25^\circ\text{C}$ $T_J = 175^\circ\text{C}$	- -	1.5 1.86	1.7 2.5	V
反向电流	I_R	$V_R = 650\text{V}$ $T_J = 25^\circ\text{C}$ $T_J = 175^\circ\text{C}$	- -	0.65 4.77	50 100	μA
总电容	C	$f = 1\text{MHz}$ $V_R = 0\text{V}$ $V_R = 200\text{V}$ $V_R = 400\text{V}$	- - -	1037 102 100	- - -	pF
总电容电荷	Q_C	$V_R = 400\text{V}$ $T_J = 25^\circ\text{C}$	-	52	-	nC
电容存储能量	E_C	$V_R = 400\text{V}$	-	12.5	-	μJ

热特性

参数	符号	测试条件	数值			单位
			最小值	典型值	最大值	
结-壳热阻	$R_{th(j-c)}$		-	0.84	-	$^\circ\text{C/W}$



典型特性曲线



图 1. 正向特性



图 2. 反向特性

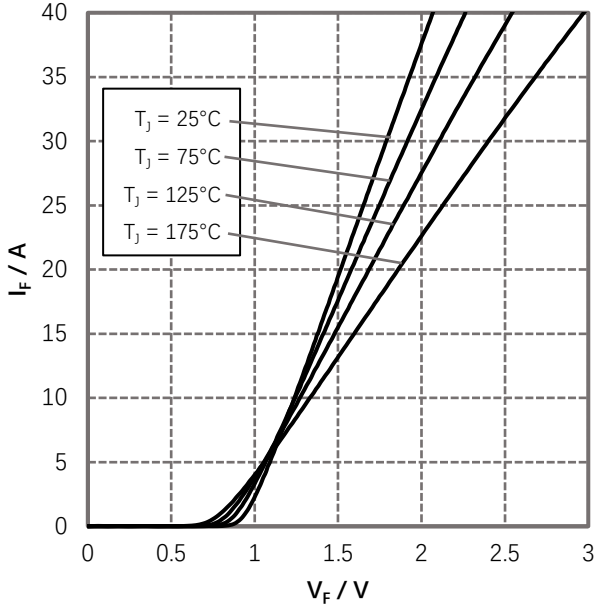

图 3. 功率降额

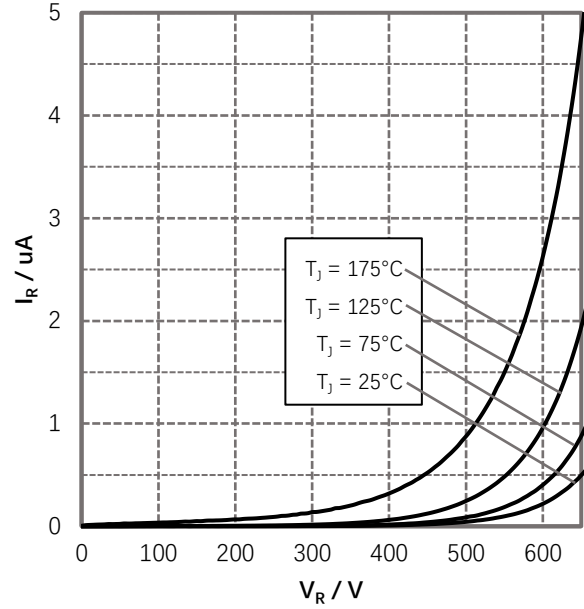

图 4. 电流降额

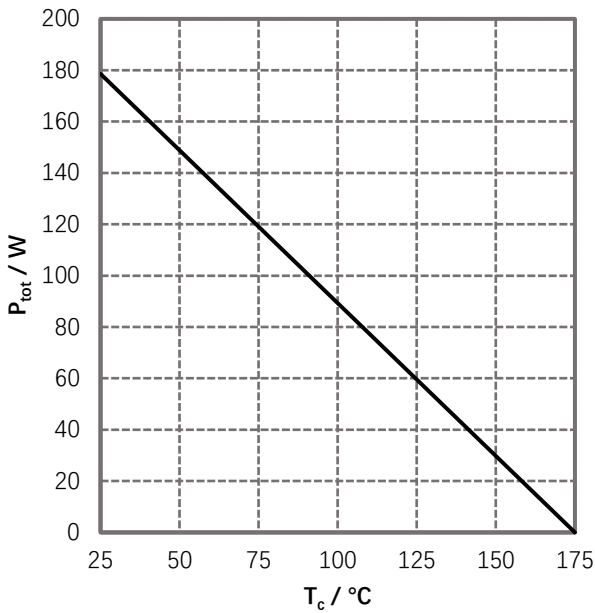

典型特性曲线

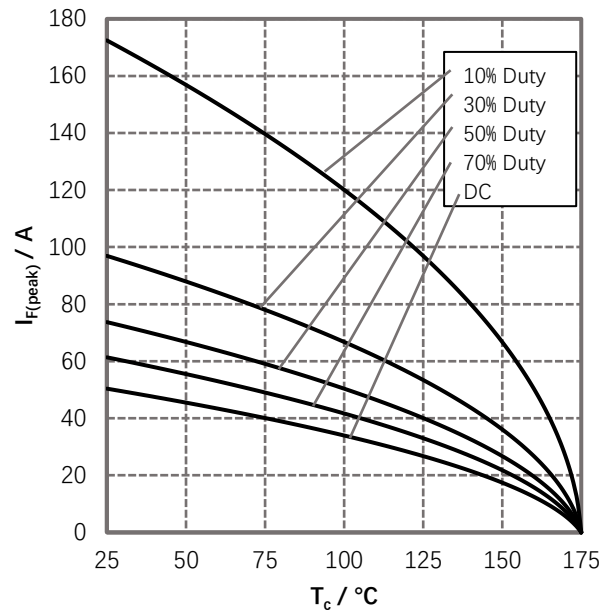

图 5. 电容-反向电压



图 6. 反向电荷-反向电压

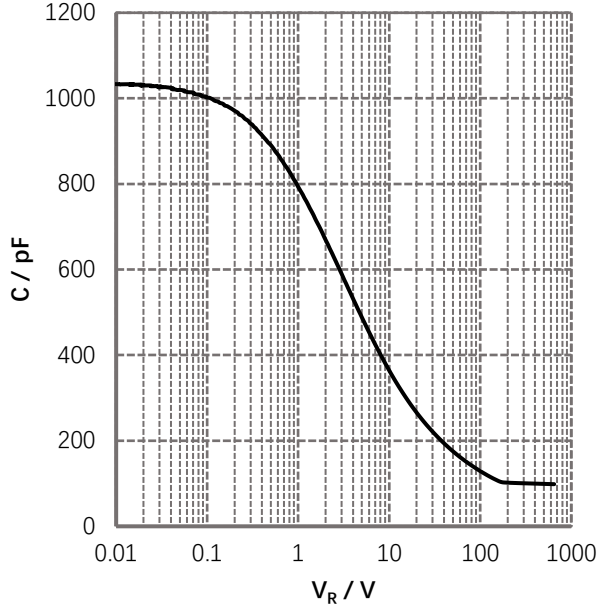

图 7. 电容存储能量

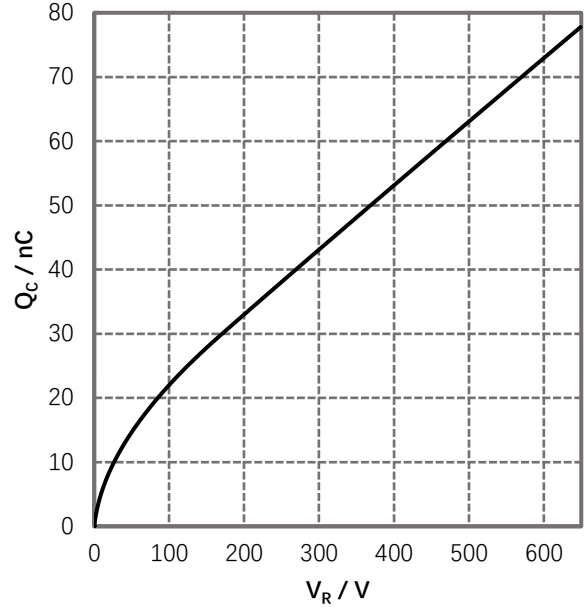

图 8. 瞬态热阻抗

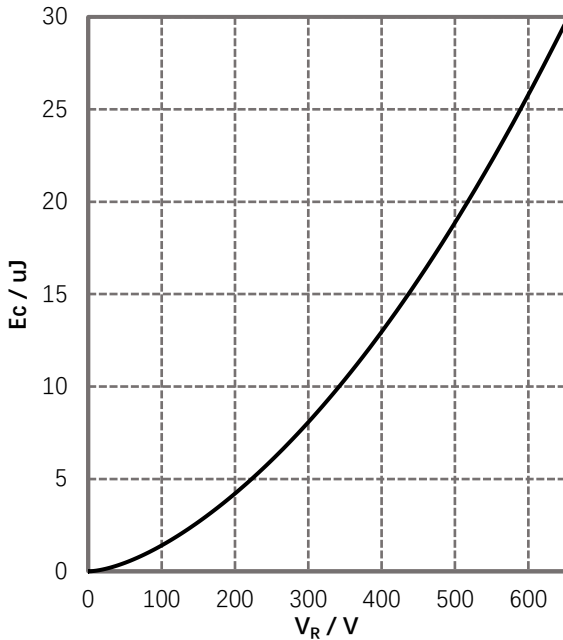

封装尺寸

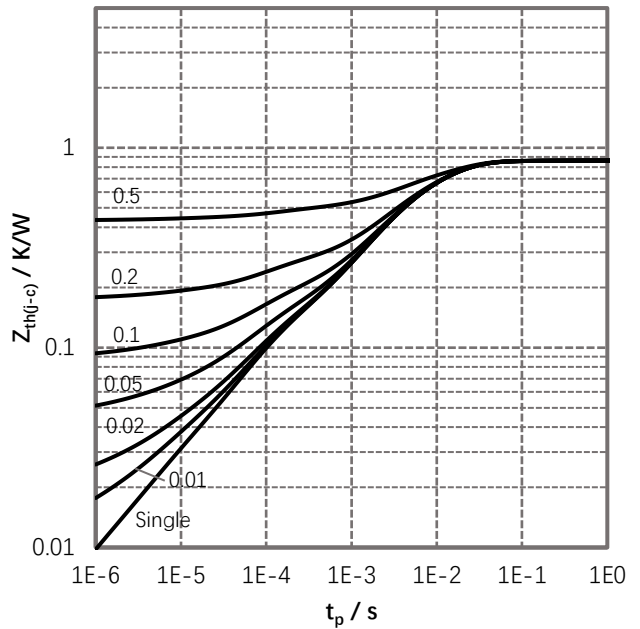
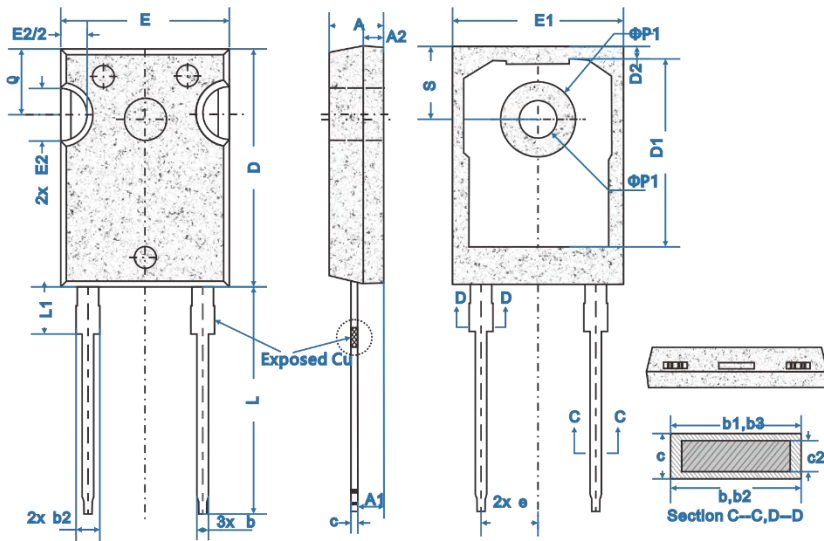

Unit: mm

Symbol	Dimensions			Notes
	Min	NOM.	Max.	
A	4.83	5.02	5.21	
A1	2.29	2.41	2.55	
A2	1.50	2.00	2.49	
b	1.12	1.20	1.33	
b1	1.12	1.20	1.28	
b2	1.91	2.00	2.34	6
b3	1.91	2.00	2.34	
c	0.55	0.60	0.69	6
c1	0.55	0.60	0.65	
D	20.80	20.95	21.10	4
D1	16.25	16.55	17.65	5
D2	0.51	1.19	1.35	
E	15.75	15.94	16.13	4
E1	13.46	14.02	14.16	5
E2	4.32	4.91	5.49	3
e	5.44 BSC			
L	19.81	20.07	20.32	
L1	4.10	4.19	4.40	6
ΦP	3.58	3.61	3.65	7
ΦP1	7.19 Ref.			
Q	5.39	5.79	6.2	
S	6.04	6.17	6.3	

Note:

1. Package reference: JEDEC TO247, variation AD.
2. All Dimensions are in mm.
3. Slot required, Notch may be rounded.
4. Dimension D & E do not include Mold Flash. Mold Flash shall not exceed 0.127 pre side. These dimension are measured at the outermost extreme of the Plastic Body.
5. Thermal Pad contour optional within dimension D1 & E1.
6. Lead finish uncontrolled in L1.
7. ΦP to have a maximum draft angle of 1.5° to the top of the part with a maximum hole diameter of 3.19mm.
8. Dimension "b2" and "b4" does not include Dambar Protrusion. Allowable Dambar protrusion shall be 0.10mm total in excess of "b2" and "b4" dimension at maximum material condition.

订购信息

型号	标记	封装	包装形式
G3S06520P	G3S06520P	TO-247AC	30pcs/管



说明

- 泰科天润半导体（北京）科技有限公司保留对其产品及物理/技术规范更改或修订的权利，恕不另行通知。
- 本文件中提供的信息在任何情况下都不应被视为对条件或特征的保证。

相关链接

- 泰科天润半导体科技有限公司网址：<http://www.globalpowertech.cn/>
- 泰科天润自营商城现已开通上线，可直接在线下单，轻松购买，原厂直发！更多详细的产品、价格信息及优惠活动，请登录泰科天润自营商城进行一键查询：<http://sc.globalpowertech.cn/>

