

## 产品特性

- 零反向恢复电流
- 零正向恢复电压
- 开关特性不受温度影响
- 适合高温工作
- 适合高频工作

$V_{RRM}$	1200V
$I_F (T_c = 150.5^\circ\text{C})$	15A*
$Q_c$	80nC*

## 产品优点

- 单极性器件
- 极大降低开关损耗
- 并联使用无热崩溃
- 降低散热片的要求

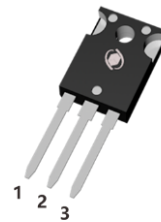

TO-247AB



内部电路

## 应用领域

- 开关电源(SMPS), 功率因数校正(PFC)
- 电动汽车/混合动力汽车
- 电机驱动器
- 光伏, 不间断电源
- 风力发电, 机车牵引

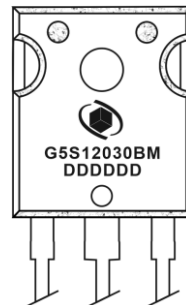

G = GPT  
5 = 第五代  
S = 碳化硅肖特基二极管  
120 = 电压等级 1200V  
30 = 电流等级 30A  
BM = TO-247AB  
DDDDDD = 追溯码



\* 单只脚 \*\* 单管



最大值 ( $T_j = 25^\circ\text{C}$ , 有特殊说明除外)

参数	符号	数值	单位
反向重复峰值电压	$V_{RRM}$	1200	V
反向浪涌峰值电压	$V_{RSM}$	1200	V
正向连续电流 $T_c = 25^\circ\text{C}$ $T_c = 135^\circ\text{C}$ $T_c = 150.5^\circ\text{C}$	$I_F$	42.6* 20.2* 15*	A
重复正向浪涌峰值电流 $T_c = 25^\circ\text{C}$ , $t_p = 10\text{ms}$ , 正弦半波	$I_{FRM}$	75*	A
非重复正向浪涌峰值电流 $T_c = 25^\circ\text{C}$ , $t_p = 10\text{ms}$ , 正弦半波	$I_{FSM}$	165*	A
$i^2t$ 值 $T_c = 25^\circ\text{C}$ , $t_p = 10\text{ms}$ , 正弦半波	$\int i^2 dt$	136*	$\text{A}^2\text{s}$
耗散功率 $T_c = 25^\circ\text{C}$ $T_c = 110^\circ\text{C}$	$P_{tot}$	181* 78*	W
工作温度	$T_j$	-55 to +175	$^\circ\text{C}$
存储温度	$T_{stg}$	-55 to +175	$^\circ\text{C}$
安装力矩, M3 螺丝	M	1	Nm

\* 单只脚    \*\* 单管



电特性 ( $T_J = 25^\circ\text{C}$ , 有特殊说明除外, 单只脚)

参数	符号	测试条件	数值			单位
			最小值	典型值	最大值	
直流阻断电压	$V_{DC}$		1200	-	-	V
正向电压	$V_F$	$I_F = 15\text{A}$ $T_J = 25^\circ\text{C}$ $T_J = 175^\circ\text{C}$	- -	1.4 1.95	1.7 2.5	V
反向电流	$I_R$	$V_R = 1200\text{V}$ $T_J = 25^\circ\text{C}$ $T_J = 175^\circ\text{C}$	- -	5.5 32	50 100	$\mu\text{A}$
总电容	C	$f = 1\text{MHz}$ $V_R = 0\text{V}$ $V_R = 400\text{V}$ $V_R = 800\text{V}$	- - -	1246 74.6 63	- - -	pF
总电容电荷	$Q_C$	$V_R = 800\text{V}$ $T_J = 25^\circ\text{C}$	-	80	-	nC
电容存储能量	$E_C$	$V_R = 800\text{V}$	-	41	-	$\mu\text{J}$

热特性

参数	符号	测试条件	数值			单位
			最小值	典型值	最大值	
结-壳热阻	$R_{th(j-c)}$		-	0.83* 0.415**	-	$^\circ\text{C/W}$

\* 单只脚 \*\* 单管



典型特性曲线 (单只脚)



图 1. 正向特性



图 2. 反向特性

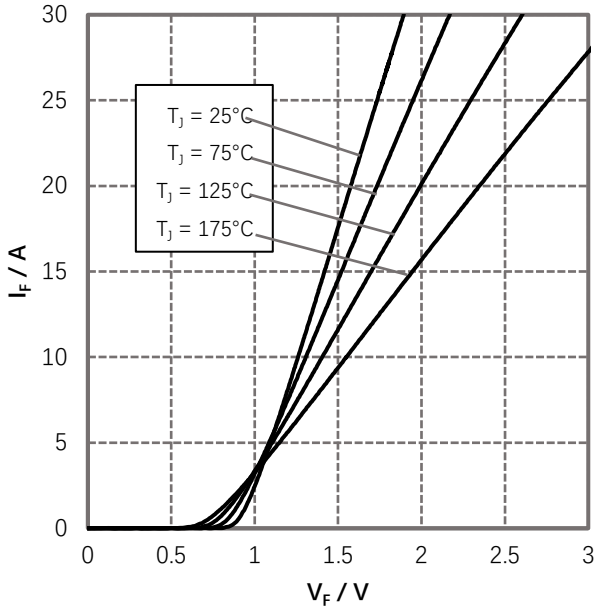

图 3. 功率降额

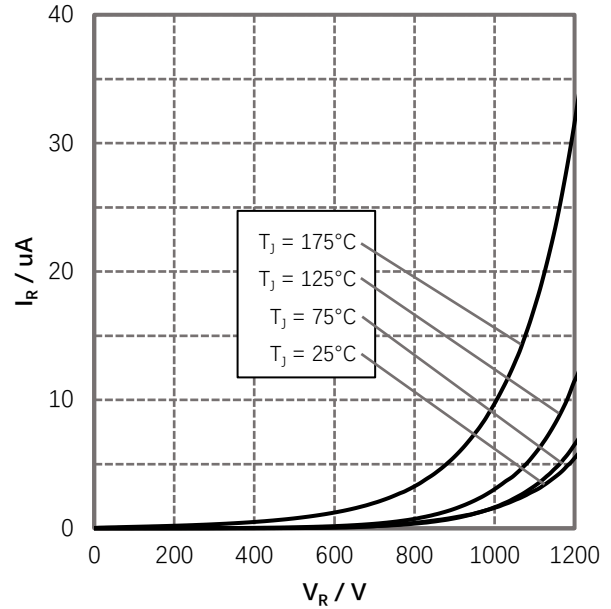

图 4. 电流降额

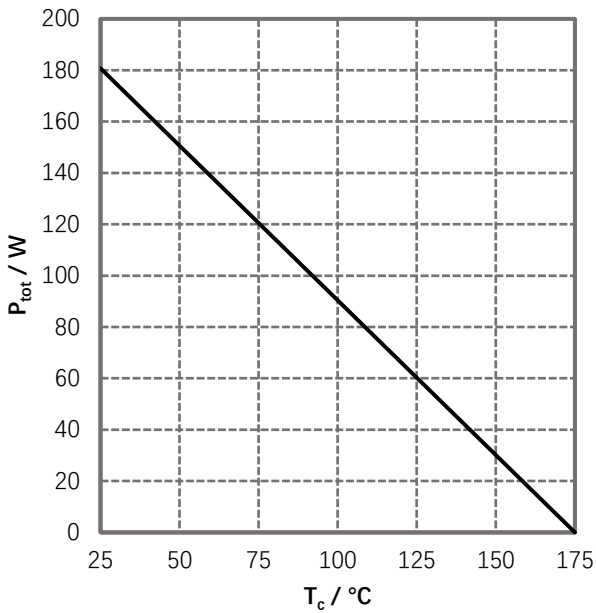

典型特性曲线 (单只脚)

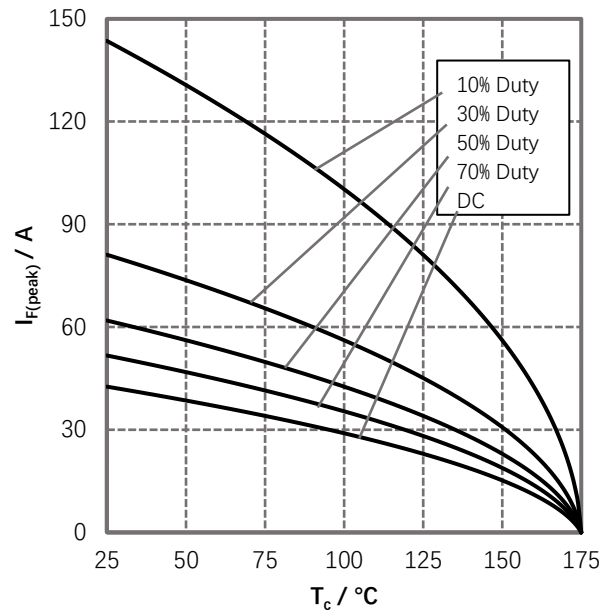

图 5. 电容-反向电压



图 6. 反向电荷-反向电压

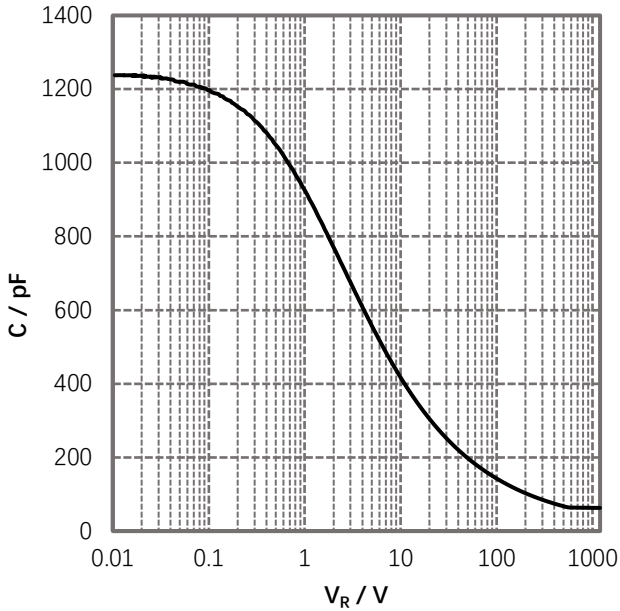

图 7. 电容存储能量

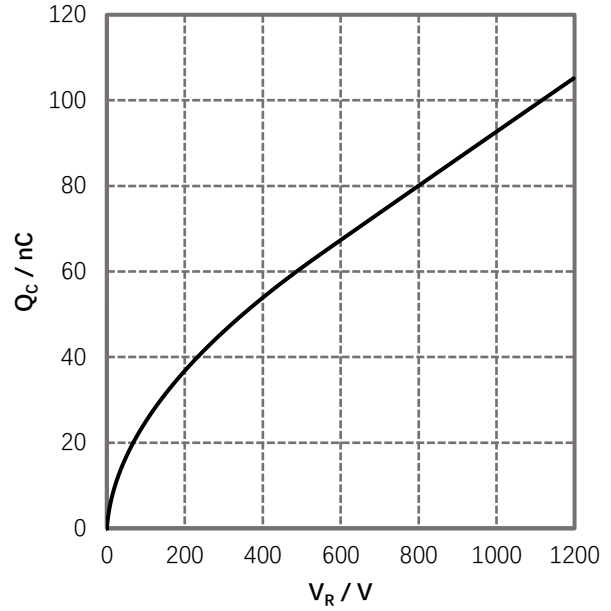

图 8. 瞬态热阻抗

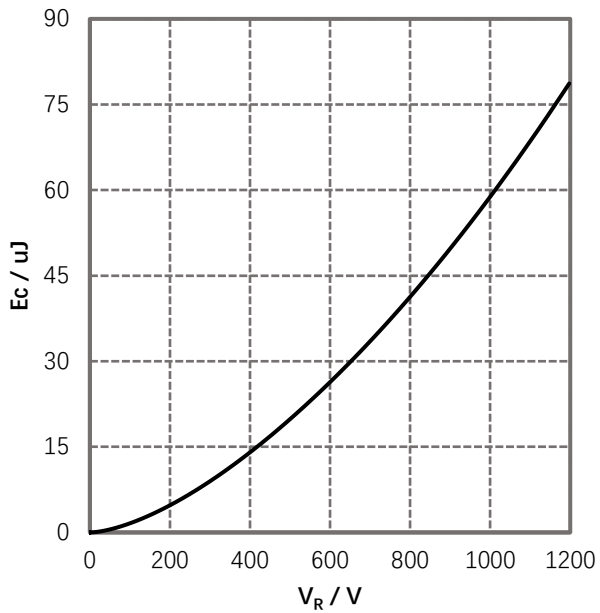

封装尺寸

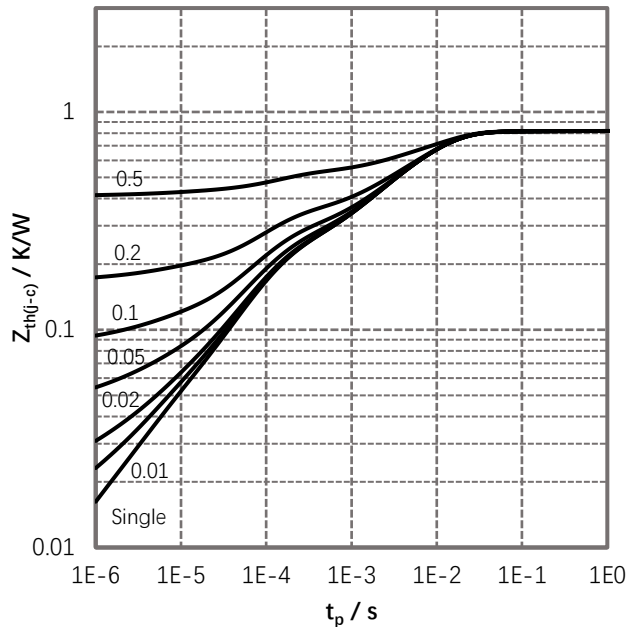
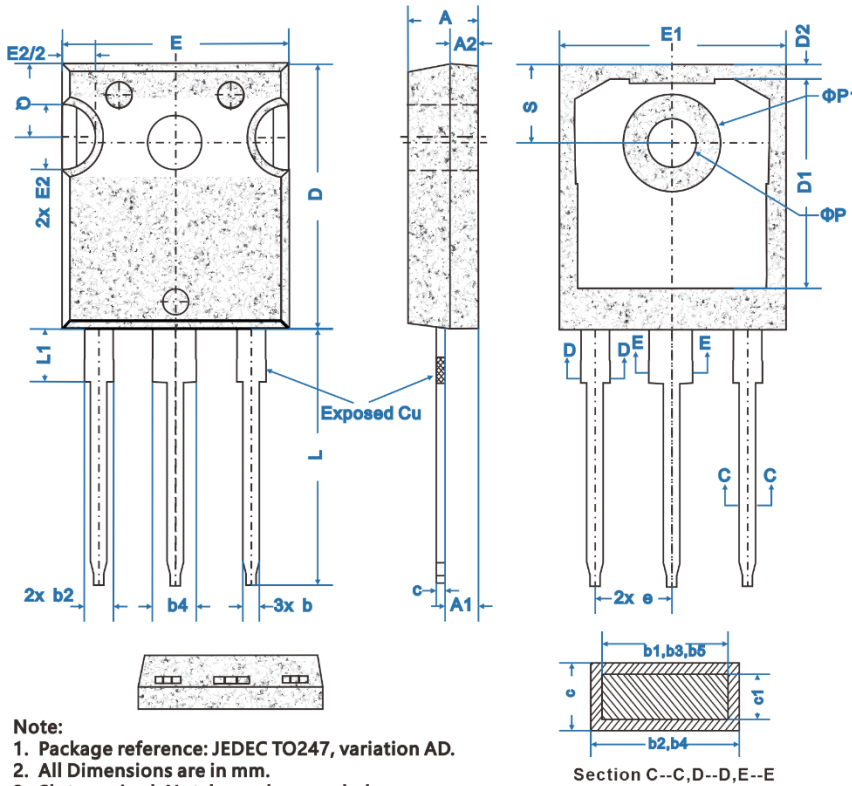

Note:

1. Package reference: JEDEC TO247, variation AD.
2. All Dimensions are in mm.
3. Slot required, Notch may be rounded.
4. Dimension D & E do not include Mold Flash. Mold Flash shall not exceed 0.127mm per side. These dimension are measured at the outermost extreme of the Plastic Body.
5. Thermal Pad contour optional within dimension D1 & E1.
6. Lead finish uncontrolled in L1.
7.  $\Phi P$  to have a maximum draft angle of 1.5° to the top of the part with a maximum hole diameter of 3.19mm.
8. Dimension "b2" and "b4" does not include Dambar Protrusion. Allowable Dambar protrusion shall be 0.10mm total in excess of "b2" and "b4" dimension at maximum material condition.

Unit: mm

Symbol	Dimensions			Notes
	Min.	NOM.	Max.	
A	4.83	5.02	5.21	
A1	2.29	2.41	2.55	
A2	1.50	2.00	2.49	
b	1.12	1.20	1.33	
b1	1.12	1.20	1.28	
b2	1.91	2.00	2.39	6
b3	1.91	2.00	2.34	
b4	2.87	3.00	3.18	6,8
b5	2.87	3.00	3.22	
c	0.55	0.60	0.69	6
c1	0.55	0.60	0.65	
D	20.80	20.95	21.10	4
D1	16.25	16.55	17.65	5
D2	0.51	1.19	1.35	
E	15.75	15.94	16.13	4
E1	13.46	14.02	14.16	5
E2	4.32	4.91	5.49	3
e	5.44 BSC			
L	19.81	20.07	20.32	
L1	4.10	4.19	4.40	6
$\Phi P$	3.58	3.61	3.65	7
$\Phi P1$	7.19 Ref.			
Q	5.39	5.79	6.2	
S	6.04	6.17	6.3	

订购信息

型号	标记	封装	包装形式
G5S12030BM	G5S12030BM	TO-247AB	30pcs/管

## 说明

- 泰科天润半导体（北京）科技有限公司保留对其产品及物理/技术规范更改或修订的权利，恕不另行通知。
- 本文件中提供的信息在任何情况下都不应被视为对条件或特征的保证。

## 相关链接

- 泰科天润半导体科技有限公司网址：<http://www.globalpowertech.cn/>
- 泰科天润自营商城现已开通上线，可直接在线下单，轻松购买，原厂直发！更多详细的产品、价格信息及优惠活动，请登录泰科天润自营商城进行一键查询：<http://sc.globalpowertech.cn/>

