

# ARK-2172

## 61-Key Multifunction Teaching-Type Digital Electronic Organ

### Operating Instructions

Thank you very much for selecting Model ARK-2172 61-key multi-function teaching-type Digital Electronic Organ.

Please carefully read this operation instruction before use for better performance and keep it properly for future reference.

# Cautions

Please read carefully before use

Please observe the following, but not limited to, rules in using the electronic organ to avoid hurt possibly incurred to yourself or anybody else and protect the electronic organ and other peripheral equipment from damaging.

1. Do not open the casing of electronic organ and try to disassembly. Do not change anything within. Should any abnormal phenomenon occur, please stop using the electronic organ immediately and send to qualified person for examination.

2. Keep the electronic organ from rain and do not use it near water or in wet condition. Do not place any vessel that holds liquid on the electronic organ for fear that liquid flows into the electronic organ.

3. Better use specified voltage (230V 50Hz), otherwise wrong voltage may cause the electronic organ impaired, overheated or wowed.

4. Before cleaning the body of electronic organ, please pull out the power plug with dry hand.

5. Regularly check up power plug and clean it if necessary.

6. Do not place power adapter or AC power cord near heat source such as heat radiator. Do not overbend or place heavy matter on electric wire. Do not place electric wire in passage. Do not wind anything on electric wire.

7. When you pull out power plug, please hold plug instead of electric wire to pull it out.

8. Do not insert the power plug of electronic organ in multi-purpose terminal block to avoid overheat.

9. When you do not use the electronic organ for a long time or in thunder, turn off the electronic organ and pull out power adapter or power plug.

10. Please turn off all power switches before connecting electronic organ to any other electronic appliance. Before turning off these electronic appliances, adjust all volume potentiometers or +- buttons to the lowest positions.

11. Do not place electronic organ in dusty, vibrating, cold or high-temperature condition (e.g. exposed to direct sunshine, near heat radiator or in the car under the sun) to avoid damage to appearance or internal components.

12. Do not place electronic organ at unstable place to avoid falling and damaging.

13. When cleaning electronic organ, please wipe its body with dry soft cloth without using dope, organic solution or chemical impregnant. Do not place vinyl plastics product on electronic organ, otherwise panel or keyboard may fade.

14. Do not sit or place heavy matter on electronic organ.

15. Do not perform with too loud volume or to the extent of hearing unwell to protect audition from hurting.

16. Please dispose plastics packing away out of infant or child to avoid danger.

17. Unpacking shall be done by adult. The small things contained in the packing are not suitable for the children below 3-years of age.

## Appendix VII: Technical Specifications

12

Standard	GB/T13837-2012; GB17625. 1-2012; GB8898-2011
Keyboard	61-key standard piano keyboard
Display	LED display
Tone	100 standard tones
Rhythm	100 well-chosen auto accompaniments
Demo song	8 stereo demo songs
Drums	8 panel drums
Effect control	Vibrato, sustain, transpose
Record	Record, replay
Program	Rhythm programming function
Accompaniment control	Start/stop, sync, fill-in, tempo
Chord control	ToneCLR, finger chord, single chord
Intelligent guide	Demo song, Guide A, Guide B
Other controls	Power switch, Main Volume, Accompaniment Volume
External port	Power jack, headphone jack, left and right sound track jack
Diapason	C2~C7
Accuracy in musical tuning	≤3 cent
Power adapter	DC9V, 500mA
Output power	6W×2
Specifications	955×380×135 (mm)
Weight	5 Kg

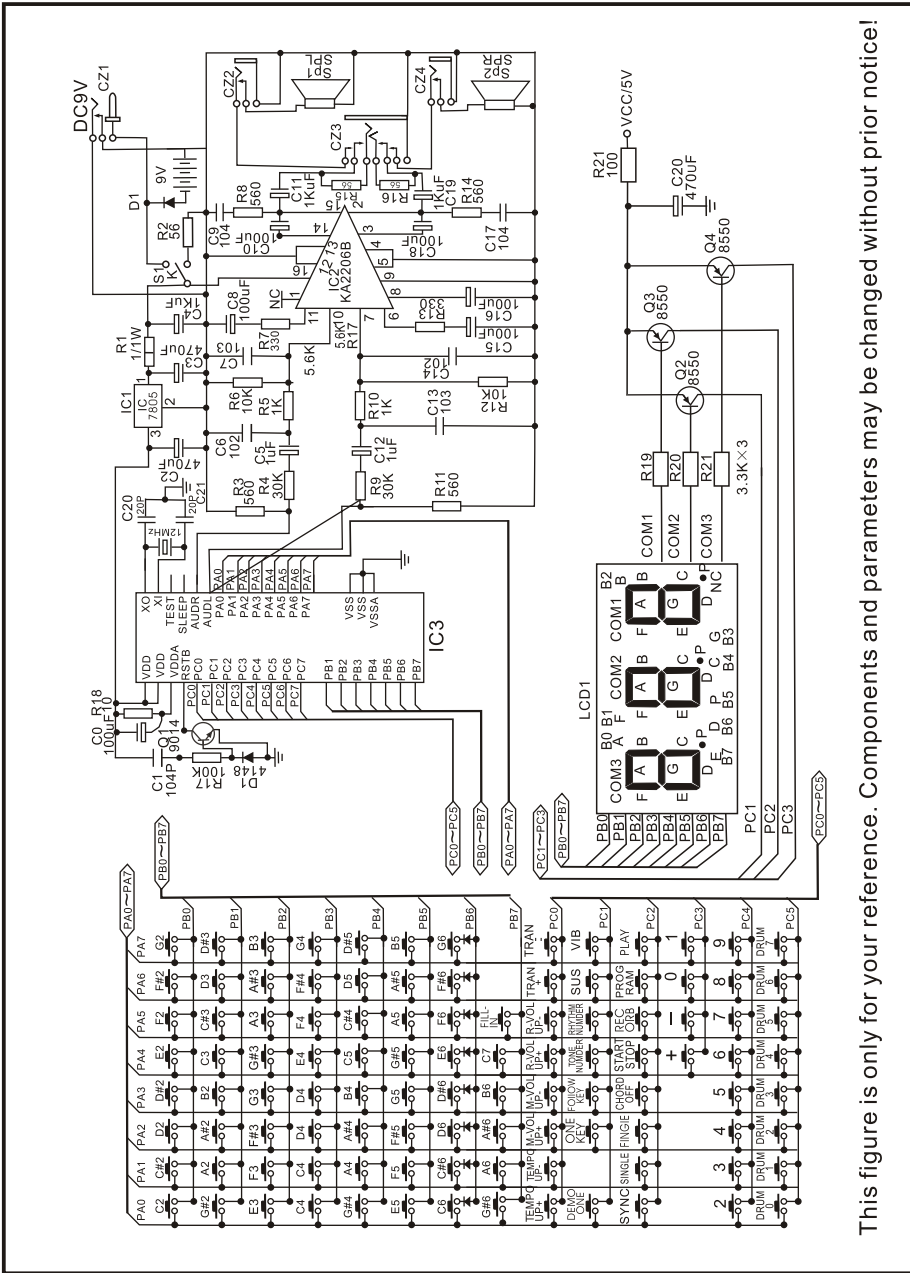

This figure is only for your reference. Components and parameters may be changed without prior notice!

- I. Panel Control and External Jack** ..... 1
  - 1. Front panel control ..... 1
  - 2. External Jacks in the rear ..... 1
- II. Preparation before Performance** ..... 2
  - 1. Using AC-DC power adapter ..... 2
  - 2. Use of batteries ..... 2
  - 3. Use of Headphone ..... 2
  - 4. Connection of Amplifier or hi-fi equipment ..... 2
- III. Basic Operation** ..... 3
  - A. Basic playing method** ..... 3
    - 1. Turn on power switch ..... 3
    - 2. Adjustment of Volume ..... 3
    - 3. Select Voice ..... 3
    - 4. Performing percussion instrument ..... 3
  - B. Auto Rhythm** ..... 3
    - 1. Select Rhythm ..... 3
    - 2. Fill in ..... 4
    - 3. Function of Sync ..... 4
    - 4. Tempo ..... 4
    - 5. RhyVol ..... 4
  - C. Auto Bass Chord** ..... 5
    - 1. Single auto bass chord ..... 5
    - 2. Finger Chord ..... 5
    - 3. ToneCLR ..... 5
    - 4. Tone Edit Function ..... 5
    - 5. Transpose function ..... 5
  - D. Record Function** ..... 6
  - E. Rhythm Programming Function** ..... 6
  - F. Intelligent Guide Function** ..... 6
    - 1. Demo Song ..... 6
    - 2. Guide Function ..... 6
- Appendix I: Table of Tone** ..... 7
- Appendix II: Table of Rhythm** ..... 8
- Appendix III: Table of Demo Song** ..... 9
- Appendix IV: Table of Panel Drum** ..... 9
- Appendix V: Trouble Shooting** ..... 10
- Appendix VI: Schematic Circuit** ..... 11
- Appendix VII: Technical Specifications** ..... 12

## 1. Front panel control:

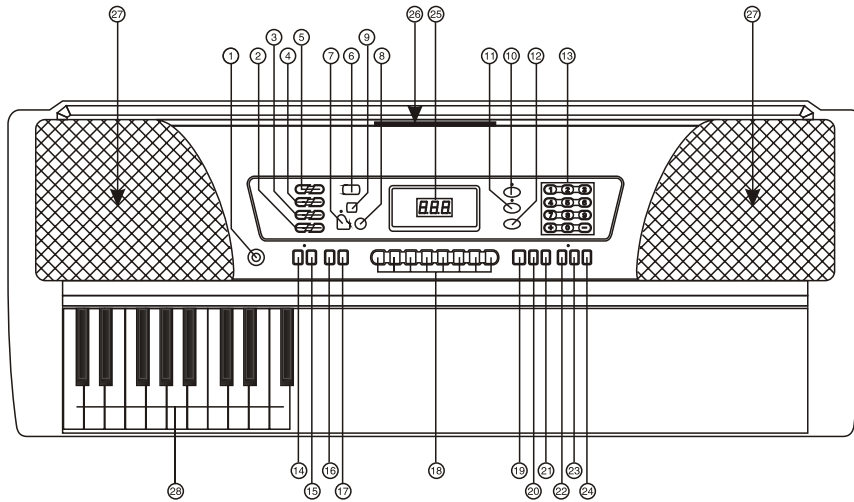

- |                 |                           |                 |                         |
|-----------------|---------------------------|-----------------|-------------------------|
| 1. Power switch | 8. Program                | 15. Vibrato     | 22. Single Chord        |
| 2. Transpose    | 9. Replay                 | 16. Guide A     | 23. Finger Chord        |
| 3. Tempo        | 10. Tone                  | 17. Guide B     | 24. Tone CLR            |
| 4. RhyVol       | 11. Rhythm                | 18. Panel drums | 25. LED display         |
| 5. Main Vol     | 12. Song                  | 19. Start/Stop  | 26. Music stand entry   |
| 6. Demo song    | 13. Digit key/ +/- button | 20. Fill in     | 27. Loudspeaker         |
| 7. Record       | 14. Sustain               | 21. Sync        | 28. Auto chord keyboard |

## 2. External Jacks in the rear:

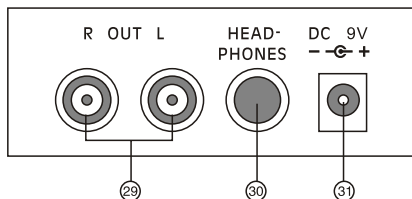

29. Left/right track audio  
30. Headphone  
31. DC 9V input

Trouble	Cause and Solution
Accompanying a little noise in turning on/off power.	Normal condition. Please do not worry.
After turning on power, press keyboard but not sound can be emitted.	Check whether volume control key is at proper position or headphone jack is held by other equipmen to break off built-in speaker system.
The note and its tone for a same voice are a little different.	This is normal phenomenon caused by different voice sampling diapason.
When using Sustain function, some tones have long sustain but some have short sustain.	This is normal phenomenon since the sustains of different tones are set to optimum lengths.
Too low volume, abnormal volume or accompaniment does not work.	Check whether volume control and accompaniment volume control are in proper setting.
Though Sync/Start is begun and keyboard is used in performance, auto accompaniment does not work.	Check whether auto bass is set on Single or Finger chord position. Now only pressing the keyboard of auto bass chord key area can accompaniment be started.
When using mobile phone, the electronic organ will emit noise.	Mobile phone can disturb the electronic organ. To avoid the noise, turn off the mobile phone or use it far away.
No t all keys pressed produces sound So long as you press keyboard, auto accompaniment function seems skipped.	You may have used too much notes than allowed quantity, including right-hand tone, left-hand tone, auto accompaniment and counterpoint note. The notes in excess of this limit will not produce sound.
The pitch of note is not correct.	Check whether the parameter of Transpose is "00".
When using batteries, the electronic organ does not emit sound after startup and indicating LED does not light up.	Check whether battery polarity is correct and batteries have run down.
When using AC adapter, you hear distorted or discontinued sound, or even the electronic organ may be halted in terrible case.	You have used unqualified AC adapter or low batteries. Please use the AC adapter provided with this electronic organ or replace batteries.
No sound for external loudspeaker or amplifier.	Check whether volume is set too low or wire connection is proper.
No sound for external microphone.	Check whether volume is set too low or wire connection is proper, or use electrer condenser microphone.

**Note:** Should the trouble of your electronic organ be unable to eliminate, please send it to franchiser or its maintenance service to repair. Do not disassembly without authorization.

## Appendix III: Table of Demo Song

Number	Code of Song	Number	Code of Song
00	Full Moon	04	Red river valley
01	Spanish Matador	05	Plum Blossom
02	Jasmin Blossom	06	For Alise
03	Seashore	07	Liu Yang River

## Appendix IV: Table of Panel Drum

Number	Name of drum	Number	Name of drum
00	Hi-Hat Closed	04	Bass Drum
01	Hi-Hat Open	05	Hand Clap
02	Low Tom	06	Hi-Hat Pedal
03	Snare	07	Slap Crash Cymbal

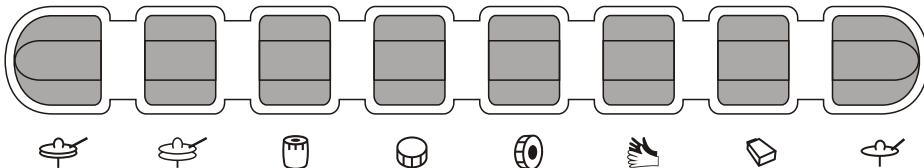

## II. Preparation before Performance

### 1. Using AC-DC power adapter:

You should use the special-purpose AC-DC power adapter provided with this electronic organ, or other power adapter with 9V DC output, 500mA output current and anode central terminal of plug. To use the power adapter, connect the DC plug in DC 9V jack of the electronic organ and another plug in mains socket (ensure input voltage of the adapter should be identical to the voltage of electric supply). Finally, turn on power switch to perform.

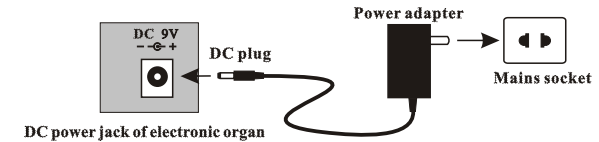

**Note:** When not using this electronic organ, please pull out the power adapter plug from mains socket, otherwise long-term energizing should cause part trouble or other accident.

### 2. Use of batteries:

Open the lid of battery jar in the bottom of electronic organ and install eight 1.5V Size D batteries (SUM-1, R20 or equivalent). Be sure to install batteries in correct PN direction marked in the lid, and recover the lid. Finally, turn on power switch to perform.

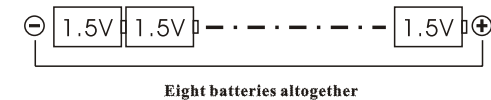

● Too low cell due to long time usage may cause less volume and distorted tone, you should replace batteries immediately, otherwise the battery leakage would impair the electronic organ.

● Do not mix new batteries with old ones or different types of battery to avoid affecting normal usage.

### 3. Use of Headphone:

In order to not affect anybody else in personal exercising or performance, please insert stereo headphone into HEADPHONE jack in the rear panel of electronic organ so that loudspeaker system in the organ will be shut off automatically.

### 4. Connection of Amplifier or hi-fi equipment:

This electronic organ has built-in loudspeaker system. Alternatively, it can also be connected to any external amplifier or hi-fi equipment. First turn off the switch of electronic organ and external equipment, then insert one end of stereo audio cable into LINE IN or AUX IN jack of other sound equipment and connect another end into OUT L/R jacks in rear panel of electronic organ.

### III. Basic Operation

#### A. Basic playing method

##### 1. Turn on power switch:

After AC adapter is connected or batteries installed correctly, press **POWER** button to turn on power switch. Press **POWER** button once again to turn off power switch of electronic organ.



##### 2. Adjustment of Volume:

This electronic organ has 16 levels of volume from 1 to 16 for your choice. The default level of volume is 12. Press Volume Up/Dn key, volume will be increased or decreased accordingly and correspondent change will be displayed on LED. Press Volume Up/Dn keys simultaneously, the VOLUME will be restored to the default level automatically. Meanwhile you adjust volume, the accompanying volume will also be changed accordingly.



##### 3. Select Voice:

This electronic organ has 100 voices (00~99) for your choice. For detailed information, refer to Appendix I.

The default status at startup is VOICE. If current status is not VOICE, you need to press VOICE key and function LED will light up. To select a VOICE throughout 00~99, please input two digits with numeric keyboard; Select VOICE can also be realized by pressing “+,-” keys. By pressing digits, LED will display corresponding VOICE code. Under VOICE status, press “+” or “-” key to select next or previous voice.

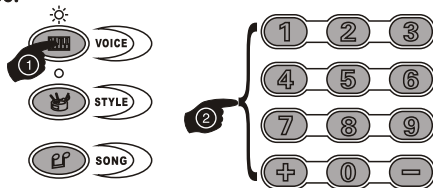

##### 4. Performing percussion instrument:

Panel drums: Press Panel drum keys (altogether 8 panel drums) to respond relevant panel drums. According to needs, performers can insert relevant panel drums to improve performance effect.

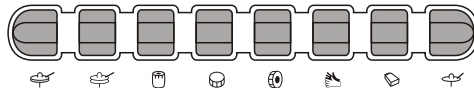

#### B. Auto Rhythm

##### 1. Select Rhythm:

This electronic organ has 100 rhythms (00~99) for your choice. For detailed STYLE table, refer to Appendix II. Press STYLE key to trigger STYLE function and function LED will light up. To select a STYLE throughout 00~99, input two digits; Select Rhythm can also be realized by pressing “+,-” keys. By pressing digits, LED will display corresponding STYLE code. Under STYLE status, press “+” or “-” key to select next or previous STYLE. After selecting STYLE, press START/STOP

### Appendix II: Table of Rhythm

No .	Name of rhythm	No .	Name of rhythm	No .	Name of rhythm	No .	Name of rhythm
00	RUMBA 1	25	SOUL 1	50	HOUSE 1	75	TECHNO
01	SAMBA	26	RAP	51	REGGAE 3	76	BALLAD
02	DISCO	27	TANGO 2	52	SOUL 2	77	DIXIE 1
03	TANGO 1	28	REGGAE2	53	POLKA 2	78	DISCO QUEEN
04	ROCK 1	29	RUMBA 2	54	HIP-HOP 1	79	ROCK 4
05	SWING	30	RAVE	55	16-BEAT 2	80	HOUSE 3
06	COUNTRY 1	31	COUNTRY 2	56	N.O.R&R	81	BLUES 2
07	WALTZ 1	32	BEAT 1	57	SLOWROCK 3	82	DANCE 3
08	BEGUINE	33	8-BEAT 1	58	8-BEAT 2	83	FUSNSHFL
09	LATIN	34	BARREL.HOUSE	59	PASODOB	84	8-BEAT 4
10	MARCH-POLKA	35	SLOWROCK 2	60	DANCE 2	85	DANCE 4
11	BOSSANOVA	36	TRIPHOP	61	WORDPOP	86	REGGAE 4
12	SALSA	37	OLDIEPOP	62	SLOWROCK 4	87	HAPPY LOVE
13	16-BEAT 1	38	ROCK2	63	8-BEAT 3	88	SKA
14	REGGAE 1	39	BIG BALLAD	64	QUICKSTP	89	CHACHA 2
15	MAMBO	40	MERENGUE	65	HIP-HOP 2	90	BROWN
16	8-BEAT	41	KERONCONG	66	MARCH 1	91	MARCH 2
17	CHACHA 1	42	GUARACHA	67	BLUES 1	92	16-BEAT 3
18	POPS	43	BIGBAND	68	CHARLESTON	93	CALIFORNIA
19	SLOWROCK 1	44	WALTZ 3	69	HOUSE 2	94	CUMBIA
20	WALTZ 2	45	ROCK 3	70	BAROQUE	95	BOLERO
21	DANCE1	46	PUNTA	71	NEW SAI DI	96	TEXMEX
22	LOUD FUSION	47	JAZZ	72	BOOGIE	97	ROCK 5
23	POLKA1	48	BEAT 2	73	DISCO BEAT	98	DIXIE 2
24	EURB	49	TRANCE	74	CANTALP	99	BOLERO

No.	Name of Tone	No.	Name of Tone	No.	Name of Tone	No.	Name of Tone
00	PIANO	25	CLEAN GUITAR 1	50	ROCK ORGAN	75	ACCORDION
01	CLARINET	26	SOPRANO SAX1	51	PICCOLO 1	76	E-PIANO 1
02	VIBRAPHONE	27	DULCIMER	52	STEEL DRUMS	77	REED ORGAN 2
03	TRUMPET	28	STRINGS 1	53	TUBA	78	HARMONICS 1
04	BANJO	29	RECORDER	54	HALO PAD	79	LOW TOM
05	FLUTE	30	ACOUSTIC GRAND PIANO	55	CLAVI	80	SOFT ACCORD
06	CHURCH ORGAN	31	ENGLISH HORN	56	FRETLESS BASS	81	SHAKHACHI
07	HARMONICA	32	SHANAI 2	57	KALIMBA	82	XIAO
08	JAZZ GUITAR	33	CLEAN GUITAR 2	58	CONTRABASS	83	HARP
09	SYNTHSTRS 1	34	ATMOSPHERE	59	NYLON GUITAR	84	E-PIANO 2
10	PIANO BRIGHT	35	VIOLA	60	PIANO ELEC 1	85	BASS LEAD 1
11	BRASS SYN	36	DRAWBAR ORGAN 2	61	PICCOLO 2	86	BASS LEAD 2
12	SYNTH BASS	37	DISTORTION GUITAR	62	SYNTHSTRS 2	87	BRASS SYN
13	LEAD SQUARE	38	STEEL GUITAR	63	PAD	88	BARITONE SAX
14	MARIMBA	39	SQUARE	64	FRENCH HORN	89	GUZHENG
15	CHORUSED PIANO	40	ALTO SAX	65	ELECTRIC GUITAR	90	CELESTA
16	ORCHES.HARP	41	ACOUSTIC BASS 2	66	FINGER BASS 1	91	XYLOPHONE
17	SAXOPHONE	42	SAWTOOTH	67	AGOGO 2	92	FINGER BASS 2
18	TANGO ACCORDIAN	43	OCARINA	68	BASSOON	93	REED ORGAN 3
19	STEEL DRUMS	44	AGOGO 1	69	FIFTHS	94	SLAP BASS 1
20	HONKY-TONKPIANO	45	MUSICBOX	70	TENOR SAX	95	HARMONICS 2
21	SHANAI 1	46	STRINGS 2	71	TINKLE BELL	96	PIANO ELEC 2
22	TROMBONE	47	OBOE	72	GLOCKENSPIEL	97	STR SYN 3
23	ACOUSTIC BASS 1	48	REED ORGAN 1	73	PIPA	98	SLAP BASS 2
24	DRAWBAR ORGAN 1	49	HARPSICHORD	74	PICK BASS	99	BASSOON

key To start STYLE and press STYLE once to exit STYLE function.

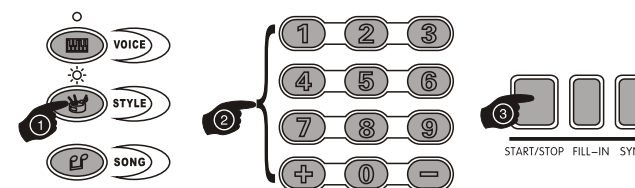

## 2. Fill in:

You may press **FILL-IN** key to insert 1-2 measures of drum fill in current rhythm to enhance performance effect and then restore to original rhythm. Only in rhythm status can this function be realized.



## 3. Function of Sync:

First press **SINGLE** chord or **FINGER** chord keys, then **SYNC** key and finally **B/W** key.

- 1.If keys belong to chord area, key and rhythm as well as chord will be played in synchronization.
- 2.If keys do not belong to chord area, this function can not be used.

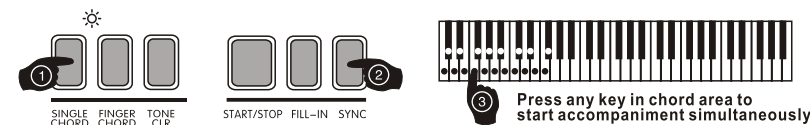

## 4. Tempo:

The default tempo is **120**. By pressing Tempo “+” or “-” key, you may correspondingly increase or decrease tempo and LED will be displayed accordingly. 32 levels of tempo may be readjusted. Press Tempo “+” and “-” keys simultaneously to restore the default tempo setting.



## 5. RhyVol:

The default RhyVol is **11**. By pressing RhyVol “+” or “-” key, you may correspondingly increase or decrease RhyVol and LED will be displayed accordingly. 8 levels of RhyVol may be readjusted. Press RhyVol “+” and “-” keys simultaneously to restore the default RhyVol setting automatically.



### C. Auto Bass Chord

#### 1. Single auto bass chord:

Press **SINGLE** key to enter the mode of single chord accompaniment, function LED will light up and **001** will be displayed on LED display. Press different single fingering in chord key area (1~19 key) to start chord accompaniment. Press **SINGLE** key once again to exit this function and **OFF** will be displayed on LED display. Chord key area will change to keyboard tone.

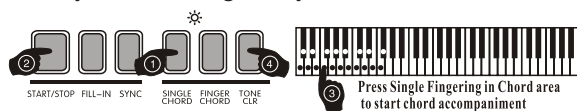

#### 2. Finger Chord:

Press **FINGER** key to enter auto bass chord function of finger chord, function LED will light up and **002** will be displayed on LED display. Press different **FINGER** in chord key area (0~19 keys) to produce correspondent chord accompaniment. Press **FINGER** key once again to exit this function and **OFF** is displayed on LED display. Chord key area will change to keyboard tone.

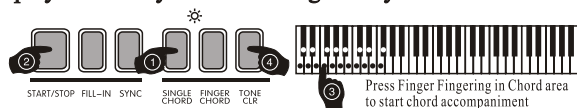

#### 3. ToneCLR:

Press **ToneCLR** key to start/stop chord background. This function is circular: start chord → stop chord → start chord..... Whenever demo song is started, the default setting of this function is to start chord. In the mode of **SINGLE/FINGER** chords, pressing this key will cancel single/finger chord accompaniment, and key pronunciation will restore to its original tone.

#### 4. Tone Edit Function:

① **Sustain:** Press **SUSTAIN** key to start sustain function, function LED will light up and **001** will be displayed on LED display. Now the note of key produces a sustain effect. Press **SUSTAIN** key once again to exit sustain function. **OFF** will be displayed on LED display and key pronunciation will restore to its original tone.



② **Vibrato:** Press **VIBRATO** key to start vibrato function, function LED will light up and **002** will be displayed on LED display. Now the note of key produces a vibrato effect. Press **VIBRATO** Key once again to exit vibrato function. **OFF** will be displayed on LED display and key pronunciation will restore to its original tone.



#### 5. Transpose function:

By pressing transpose “+” or “-” key, you may increase or decrease half note when you perform with b/w keys, with ± 6 levels adjustable. Press transpose “+” and “-” keys simultaneously to restore to its default note.



### D. Record Function:

Press **RECORD** key to begin recording, function LED will light up. **ON** will be displayed on LED display. Before recording, you should set tone, rhythm, tempo and auto chord in good order to minimize setting during record. Now performer may play according to his/her free will and the notes produced by the electronic organ will be recorded until the recorded quantity of note exceeds the maximum limit and **FUL** is displayed on LED display. In Recode mode, press **REPLAY** key to replay recorded notes in sequence. In replay mode, tone may be switched. Upon completion, press **RECORD** key once again to exit the function and **OFF** will be displayed on LED display. In this mode keyboard transpose function will not work.

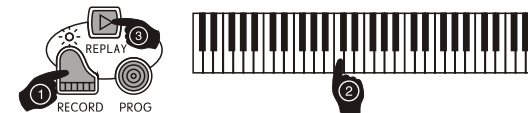

### E. Rhythm Programming Function:

Press **PROG** key to enter rhythm programming function and **ON** is displayed on LED display. By pressing eight panel drums, you can program correspondent drums in the organ. When the number of programs exceeds the maximum limit, **FUL** will be displayed on LED display and **PROG** mode will be ended. Press a key in **PROG** mode to program an empty beat and replay the sound of beep. Press **REPLAY** key to replay programmed drums in sequence and cycles and form a self-programmed rhythm. By readjusting tempo “+/-” key, you may reach the optimal performance effect. In replaying programmed rhythm, press **REPLAY** or **Start/Stop** key to stop replaying.

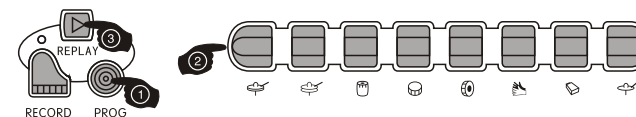

### F. Intelligent Guide Function

1. **Demo Song:** This electronic organ has 8 demo songs. For the table of demo songs, refer to Appendix III.

Press **Demo Song** key to replay current demo song. During replaying, press **Demo Song** key once again to replay next demo song. This key is a toggle key. Press this key to replay 8 demo songs in sequence.



#### 2. Guide Function

Press **Guide-A** or **Guide-B** key to enter Guide function. During guide, unless a key be pressed, the song will not be continued. After a song is finished, repeat it again. You can select a demo song by Demo song key. In Guide mode, press **Guide-A** or **Guide-B** key to exit guide function.

**Guide-A:** No matter whether you perform correctly or not, the organ will emit correct notes, namely the type of one key one note



**Guide-B:** The theme notes will be screened by the notes played and if you do not play for 3 seconds, the theme notes will be restored for guide purpose.

