

## Operating instructions

### **RYMASKON<sup>®</sup> 700-BACnet**

### **RYMASKON<sup>®</sup> 700-Modbus**

Room control unit with colour touch screen,  
with BACnet or Modbus connection

Interface for controlling temperature,  
fans, light, A/C (air conditioning) (1 zone) and  
blind (2 zones)



## INSTALLATION AND COMMISSIONING

Commissioning is mandatory and may only be performed by qualified personnel! Please read these instructions prior to installation and commissioning, and comply with the specifications that they contain!

Mounting shall take place while observing all relevant regulations and standards applicable for the place of measurement (e.g. such as welding instructions, etc.). It is particularly important to comply with the following:

- VDE / VDI technical temperature measurements, directives, measurement set-ups for temperature measurements.
- EMC directives
- It is imperative to avoid parallel routing of current-carrying lines
- We recommend the use of shielded cables with the shielding attached to the DDC/PLC at one side.

Before mounting, make sure that the existing technical parameters of the measuring instrument comply with the actual conditions at the place of utilization, particularly with regard to:

- the measuring range
- the maximum permissible temperature and humidity
- the protection type and protection class
- oscillation, vibration and impacts must be avoided (< 0.5 g)

### Devices with integrated CO<sub>2</sub>-Sensor

Devices with integrated CO<sub>2</sub>-Sensor have **an automatic calibration of the carbon dioxide measurement - ABC logic**. The Automatic Background Logic is a self-calibrating mechanism that is suitable for use in applications in which the CO<sub>2</sub> concentration regularly drops to fresh air level (350 - 500 ppm). This should typically happen at times during which the rooms are unoccupied. The sensor reaches its normal accuracy after 24 hours of continuous operation in an environment which has been exposed to a fresh air supply of 400 ppm CO<sub>2</sub>. The deviation error remains minimal with at least 4 cases of sensor exposure to fresh air within 21 days. The ABC logic requires continuous operating cycles of longer than 24 hours in order to function properly.

## IMPORTANT NOTES

**Only the valid edition of our conditions and the valid "General Conditions for the Supply of Products and Services of the Electrical and Electronics Industry" (ZVEI conditions) and the supplementary clause "Extended Retention of Title" apply as the terms and conditions regulating this purchase.**

The following points must also be complied with:

- These instructions must be read before installation and commissioning, and all of the specifications that they contain must be complied with.
- The units must only be connected to an extra-low safety voltage in a de-energised condition. Use shielded cables to avoid damage to the unit and faults (e.g. resulting from voltage induction), avoid parallel routing with live lines, and comply with the EMC directives.
- This unit must only be used for its intended purpose, whereby the applicable VDE safety regulations and all regulations issued by the regional and national regulatory authorities, TÜV and local energy providers must be complied with. The purchaser must ensure that the relevant building and safety regulations are complied with, and must avoid hazards of all kinds.
- No warranty or liability whatsoever will be accepted for defects and damage arising from improper use of this unit.
- The warranty and liability excludes consequential damage caused by a fault in this unit.
- The units must only be installed and commissioned by qualified personnel.
- Only the technical data and connecting conditions specified by the installation and operating instructions which are included in the scope of delivery of the unit apply. Deviations from the depictions contained in the catalogue are not additionally listed, and are possible as a result of technical progress and the continuous improvement of our products.
- Any alterations made to the unit by the user will void the warranty.
- This unit must not be installed close to sources of heat (e.g. radiators) or their heat flow. Avoid direct solar irradiation or heat radiation from similar sources (powerful lamps, halogen spotlights).
- Operating this unit close to other devices that do not comply with EMC directives may influence the functionality thereof.
- This unit must not be used for monitoring purposes which serve the purpose of protecting persons against hazards or injury, as an Emergency Stop switch on systems or machinery, or for any other similar safety-related purposes.
- The housing dimensions and the dimensions of accessories may differ slightly from the specifications of these instructions.
- Changes to these documents are not permitted
- In cases of complaint, we will only accept complete units returned in their original packaging.

## INSTALLATION

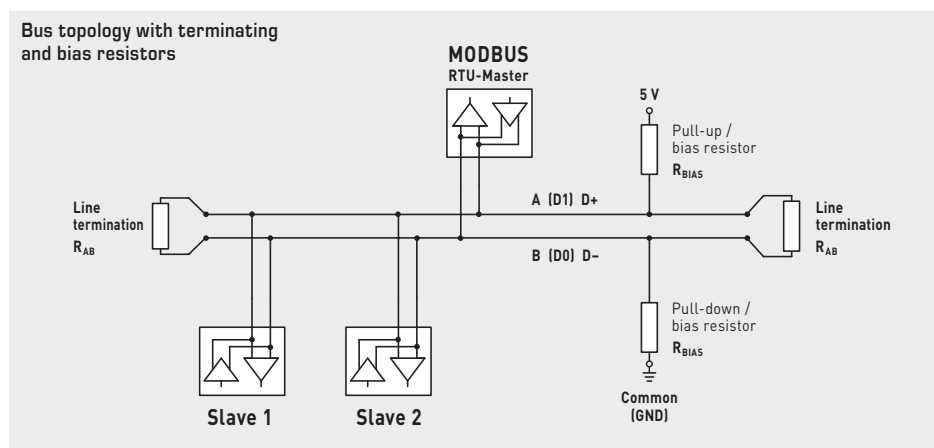
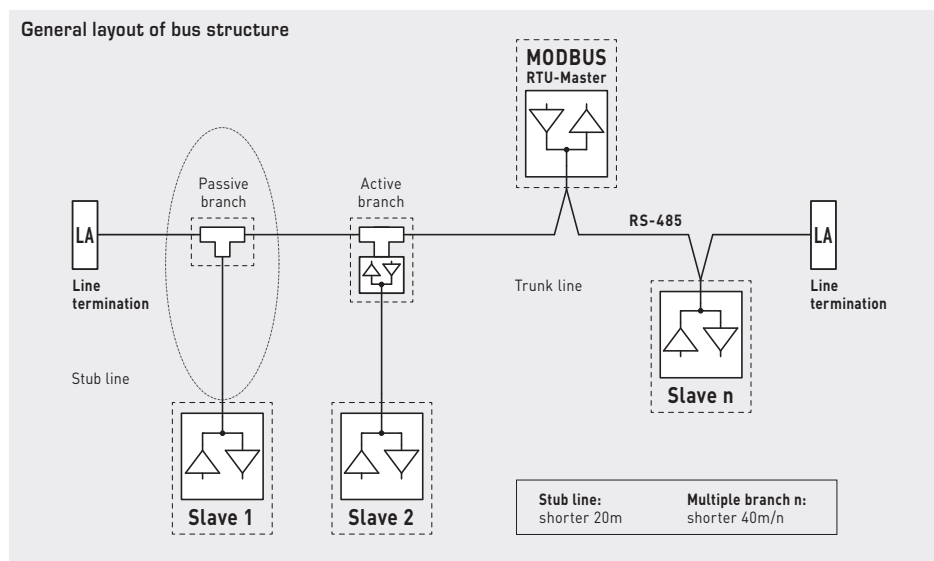

Terminating resistors may only be installed at the ends of the bus line.  
 No more than two line terminators are permitted in networks without repeaters.  
 The bias resistors for bus level definition in the idle state are usually activated at the Modbus master / repeater.

The maximum number of subscribers per Modbus segment is 32 devices.  
 With a greater number of subscribers, the bus must be subdivided into several segments separated by repeaters. The subscriber address can be set from 1 to 247.

A cable with a twisted-pair data line / power supply line and copper shielding braid must be used for the bus line. The line capacitance should be less than 100 pF/m (e.g. Profibus cable).

## CONFIGURATION

The communication interface must be configured from the unit (see parameter table - System page 29). All other parameters can also be changed via the Modbus master.

Changed communication parameters are activated when Setting Mode is exited; the unit performs a soft reset. Alternatively, the new settings can also be activated by switching the unit off and on again (deactivate and reactivate supply voltage).

The configuration parameters are stored in the non-volatile memory of the controller. After changing the configuration via the display, the new parameters are saved when the controller returns to Normal Display Mode.

If the changes were made via the bus (Modbus), the parameter for updating the non-volatile memory is required in order to force saving. If configuration takes place via the display, the parameters are saved after an expiry time or when the settings menu is closed.

An **existing configuration** can be **transferred** to other units using the **RYMASKON USB-CT** configuration tool (see next page).

### RYMASKON USB-CT

Configuration tool  
 for rapid transfer of the  
 unit configuration



A configuration can be transferred to other units.

To do so, a unit must first be configured using the display via the bus.

After which the **RYMASKON USB-CT**  
 and software on the PC can be used to transfer the configuration to other units.

The current software and detailed information are available in the **RYMASKON USB-CT**  
 download area ([spluss.de/r/2L6VM.htm](http://spluss.de/r/2L6VM.htm)).

Connection plan of the configuration tool

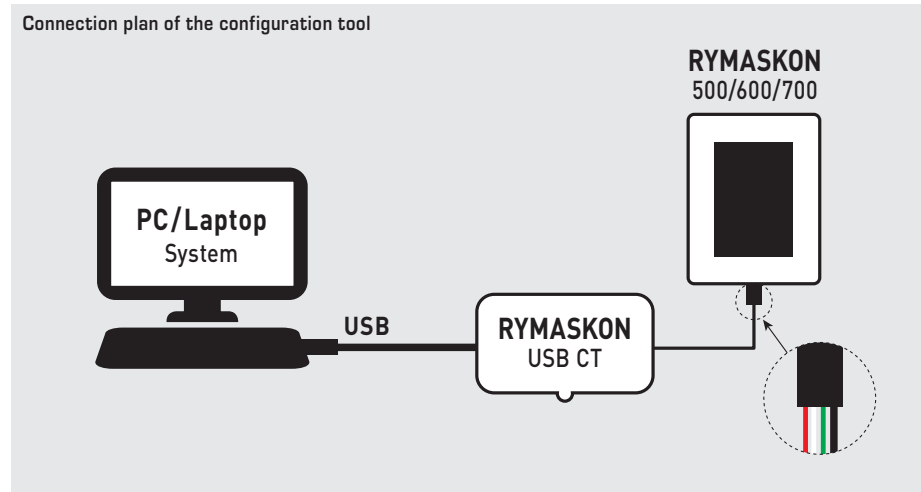

### KEY FEATURES

Basic model type 710

- 24 V AC/DC voltage supply
- 3.5 inch touch display with backlighting
- Modbus or BACnet
- Wall mounting on standard in-wall flush boxes
- Integrated temperature sensor (basic equipment)
- Integrated humidity sensor
- Integrated CO2 sensor (optional)
- Regulation of heating, cooling, fans  
via the bus
- Operation of temperature,  
fan, light, A/C (air conditioning) (1 zone)  
and sun protection (2 zones)  
via touch display
- 2 resistance inputs (NTC10K)  
for external temperature sensors
- 1 relay output (7A / 0.5A with CO2)  
as 2-point regulator (potential-free)  
controllable via bus
- 1 digital input (potential-free)
- Operating modes Comfort (Normal),  
OFF, Party (Boost), ECO, Frost Protection

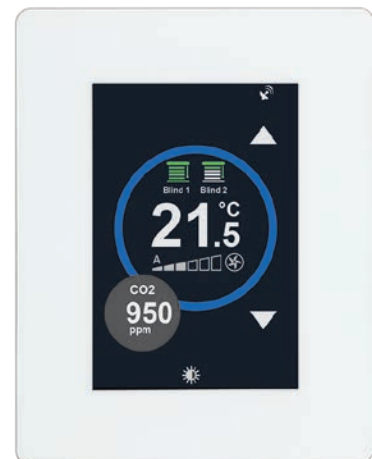
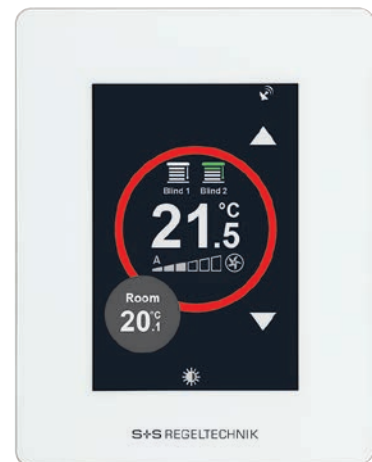

**DESCRIPTION**Introduction and  
technical data

The RYMASKON® 500 / 600 / 700 series of room control units are designed for controlling the climatic zone in residential, hotel and office rooms and individually regulate the heating/cooling steps of the internal rooms. A colour touch display with modern icons is used for the visual display and operation at the location. The product range is characterised by the variety of combination options of the individual components.

The RYMASKON® 700 Interface series controls via the bus **heating or cooling valves, fan speed and the sun protection** (blinds, shutters) in two zones. Through the appropriate symbols, it is possible to control the light and air conditioning instead of the sun protection. In addition to the integrated temperature sensor, two external temperature sensors (NTC10K) can also be connected. Measuring elements for relative humidity and CO<sub>2</sub> are also available. The devices are used in room climate technology, including convector fans, cooling ceilings and heating/cooling systems. Wall mounting is performed on standard in-wall flush boxes. The devices are optionally available with a Modbus or BACnet communication interface and in various type versions (see number key).

The basic model RYMASKON® 710 Interface with colour touch display (3.5"), in a white housing, possesses an integrated temperature and humidity sensor (CO<sub>2</sub> sensor optional), 2 resistance inputs (NTC10K) for external sensors, 1 digital input, 1 relay output (7 A / 0.5 A with CO<sub>2</sub>) and optionally with Modbus or BACnet connection. The room control units are used for controlling temperature, fans and sun protection (2 zones) via the bus.

TECHNICAL DATA	(Basic model)
Device type:	room control unit
Functions:	temperature, fan, light, air conditioning (1 zone), and sun protection (2 zones)
Communication:	<b>Modbus RTU Slave</b> address range can be configured between 1...247 or <b>BACnet MS/TP</b> device ID 65100 (default) and MAC address can be configured between 1...127 RS 485 interface, max. 63 devices, 9600 / 19200 / 38400 / 57500 / 76800 Baud, none / even / odd parity, 1 / 2 stop bits
Voltage supply:	24 V AC/DC (± 15%)
Power consumption:	max. 1.92 W
Inputs:	2 resistance inputs (NTC10K) for external temperature sensors 1 digital input (potential-free), impedance <1 kOhm
Outputs:	1 relay output (2-point regulation) without CO <sub>2</sub> : 7 A (resistive load); 1.3 A (inductive load) with CO <sub>2</sub> : 0.5 A (resistive/inductive load)
Operating mode:	Comfort, ECO, OFF, Boost
Control element:	<b>3.5" touch display</b> with backlighting, cut-out approx. 50 x 75 mm, resolution 320 x 480 pixels, 255,000 colours
<b>TEMPERATURE</b>	
Sensor:	integrated temperature sensor
Measuring range:	-40...+125 °C
Accuracy:	typically ±0.5 °C at +25 °C
<b>HUMIDITY</b>	
Sensor:	integrated humidity sensor
Measuring range:	0...100% RH
Accuracy:	typically ±2% RH (20...80% RH) at +25 °C
<b>CARBON DIOXIDE (CO<sub>2</sub>)</b>	
Sensor:	optical NDIR sensor (non-dispersive infrared technology), with automatic calibration
Measuring range:	0...5000 ppm
Accuracy:	typically ±50 ppm ±3% of the measured value at +25 °C
Electrical connection:	0.14 - 1.5 mm <sup>2</sup> , via screw terminals≠
Housing:	plastic, polycarbonate material, self-extinguishing, white colour (optionally black or chrome), weight approx. 220 g
Housing dimensions:	approx. 88 x 112 x 14.5 mm (on-wall) approx. 88 x 112 x 20.5 mm (on-wall with CO <sub>2</sub> sensor) approx. 52 x 53 x 28.5 mm (in-wall)
Mounting:	wall-mounting on in-wall flush box, Ø55 mm
Ambient temperature:	0...+50 °C (operation); -30...+70 °C (storage)
Permitted humidity:	0...95% RH, (non-precipitating air)
Protection type:	<b>IP 20</b> (according to EN 60529)
Standards:	CE conformity, according to EMC directive 2004/108/EU, Low-Voltage directive 2006/95/EU, according to EN 61000-6-1/3, EN 60730-1, EN 6100-4-2/4/5/11

**RYMASKON® 700 Interface (series)**  
 Number key for type versions

**RYM7-10IX-XX0X-000**

<b>Pos. 1-4</b>	<b>Type name</b> RYMASKON 700	RYM7
<b>Pos. 5</b>	<b>Channel configuration</b> Type 710 2RI, 1DI, 1RO 7 A / 0.5 A with CO2	1
<b>Pos. 7</b>	<b>Device type</b> Interface	I
<b>Pos. 8</b>	<b>Communication</b> Modbus BACnet	M B
<b>Pos. 9</b>	<b>Voltage supply</b> 12 V DC 24 V AC/DC	1 2
<b>Pos. 10</b>	<b>Additional measuring elements</b> without * RH (rel. humidity) CO2 (carbon dioxide) RH + CO2	0 1 2 3
<b>Pos. 11</b>	<b>Extra options</b> without	0
<b>Pos. 12</b>	<b>Housing colour</b> black white chrome	1 2 3

Pos. 5    **RI** Resistance input (NTC10K) for external temperature sensors  
           **DI** Digital input (potential-free)  
           **RO** Relay output (7 A), (2-point regulation)

Pos. 10 \*    The **temperature sensor** forms part of the basic equipment and is included in the option "without" additional measuring elements.

**RYMASKON® 710 Interface (basic model)**

Type / WG02	Communi-cation	Measuring element	Control system	Colour	Display	Item No.
Rymaskon 712-MOD-RH	Modbus	T   RH	T   V   2S   L   K	white	■	RYM7-10IM-2102-000
Rymaskon 712-MOD-RH-CO2	Modbus	T   RH   CO2	T   V   2S   L   K	white	■	RYM7-10IM-2302-000
Rymaskon 712-BAC-RH	BACnet	T   RH	T   V   2S   L   K	white	■	RYM7-10IB-2102-000
Rymaskon 712-BAC-RH-CO2	BACnet	T   RH   CO2	T   V   2S   L   K	white	■	RYM7-10IB-2302-000
Measuring element / control system:	<b>T</b> = Temperature sensor (basic equipment) <b>RH</b> = Humidity sensor <b>CO2</b> = Carbon dioxide sensor		<b>T</b> = Temperature <b>V</b> = Fan <b>S</b> = Sun protection (2 zones) <b>L</b> = Light <b>K</b> = Air Conditioning AC			

Channel configuration:  
**2RI** 2 Resistance inputs (NTC10K) for external temperature sensors  
**1DI** 1 digital input (potential-free)  
**1RO** 1 Relay output (7 A), (2-point regulation)

Type variants:  
 Basic model **Typ 710** available from stock – freely configurable type variants available upon request!  
 For configuration options, see number key (above).

**ACCESSORIES**

RYMASKON USB_CT	<b>Configuration Tool</b> for quick transfer of the device configuration from the PC to all devices in the building	1901-51Z3-0002-000
-----------------	---	--------------------

## DIMENSIONAL DRAWING

Dimensional drawing  
[mm]

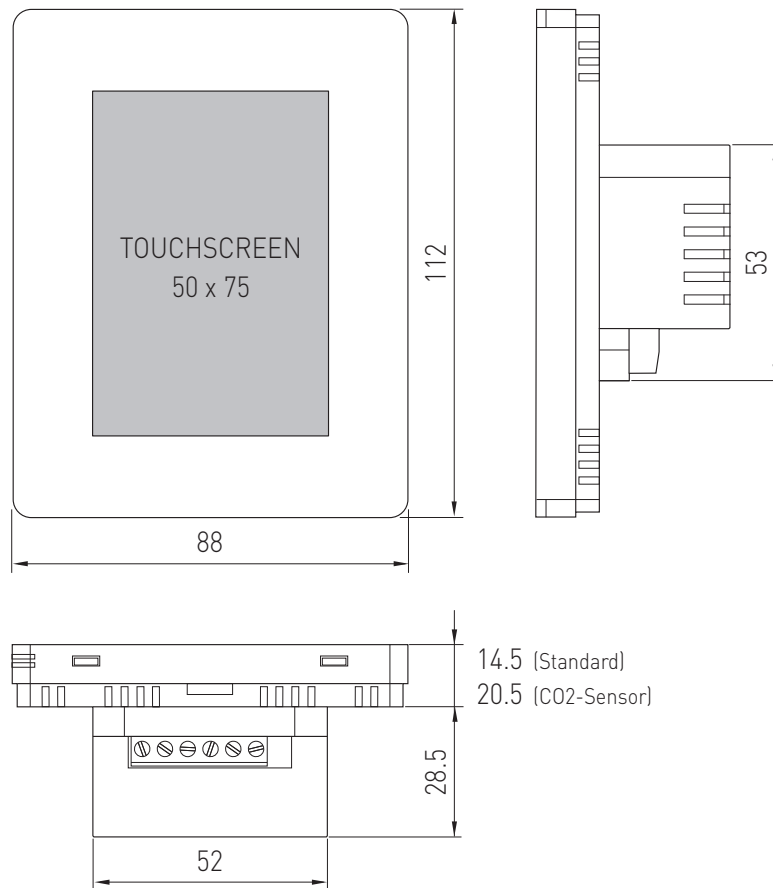

## WIRING

Connection diagram  
basic model

### WARNING:

**Switch off the power supply before commencing the wiring work!**

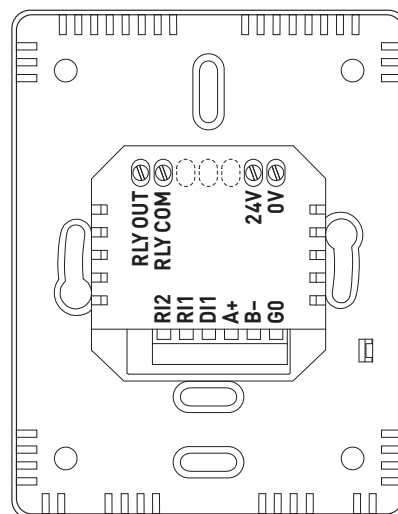

### RYMASKON 710

<b>RLY</b>	30V DC
<b>OUT</b>	Rated Relay Output
<b>COM</b>	Relay Common Terminal
<b>24V</b>	24V AC/DC Supply
<b>0V</b>	0V Supply
Inputs	
	NTC10K Temperature Sensor
<b>R11</b>	Input 1 (External Sensor)
<b>R12</b>	Input 2 (External Sensor)
<b>DI1</b>	Digital Input (Potential-free)
Modbus / BACnet MS/TP	
<b>A+</b>	RS485 A+
<b>B-</b>	RS485 B-
<b>G0</b>	GND

## USER INTERFACE

Screens, lighting  
and calibration

The following diagrams show typical display features of the **RYMASKON® 700 Interface**.

All icons and functions can be revealed and hidden individually.

The multicolour touch screen visualizes the actual state of the system

The **large ring** (red/blue/white) shows the current temperature setpoint.

The colour of the large ring can be set via the bus. The intensity of the ring colour changes depending on the difference between the target temperature and the actual temperature (default, internal sensor 3).

The small **action circle** (grey) displays the current sensor values alternately (if enabled).

MAIN SCREEN

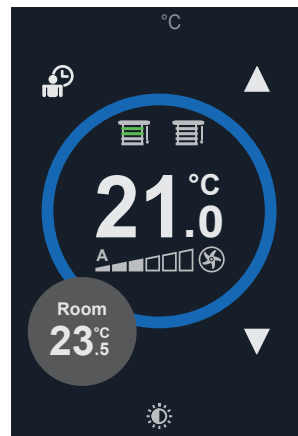

Fig. 1a Main screen

AUXILIARY SCREEN

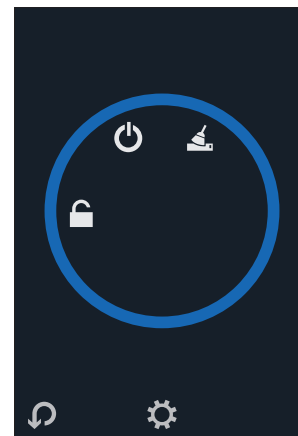

Fig. 1b Auxiliary screen  
(opens by tapping the grey action circle on the main screen)

BLIND SCREEN

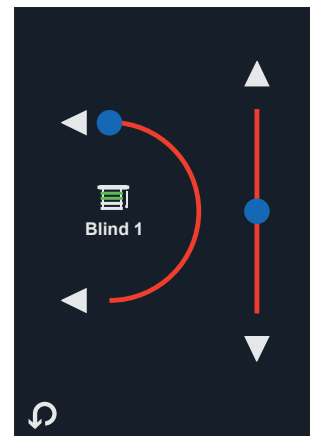

Fig. 1c Blind screen  
(opens by tapping the Blind icon on the main screen)

### Screen backlighting (standby)

If the display of the main screen is not touched for 30 sec., the display will be dimmed to the set standby value (default 5 / max. 20).

The brightness of the touch display in standby can be adjusted in the settings (display - brightness).

If this value is configured to 0, the display is completely dark following inactivity.

Touching the display reactivates the backlighting.

Tapping the  icon on the **main screen** dims the display to the set value immediately.

Tapping the icon again in standby switches off the backlighting completely.

### Screen calibration

The touch display can be re-calibrated during a unit reset.

The unit performs the following two types of reset:

1. Upon unit start (power supply present)
2. After ending the parameter settings in Setting Mode and returning to the main screen.

During the reset (dark screen), swipe in the direction of all four edges of the display and then follow the instructions. Confirm the recalibration with OK



## MAIN SCREEN ICONS

Screen areas and  
explanation of the icons

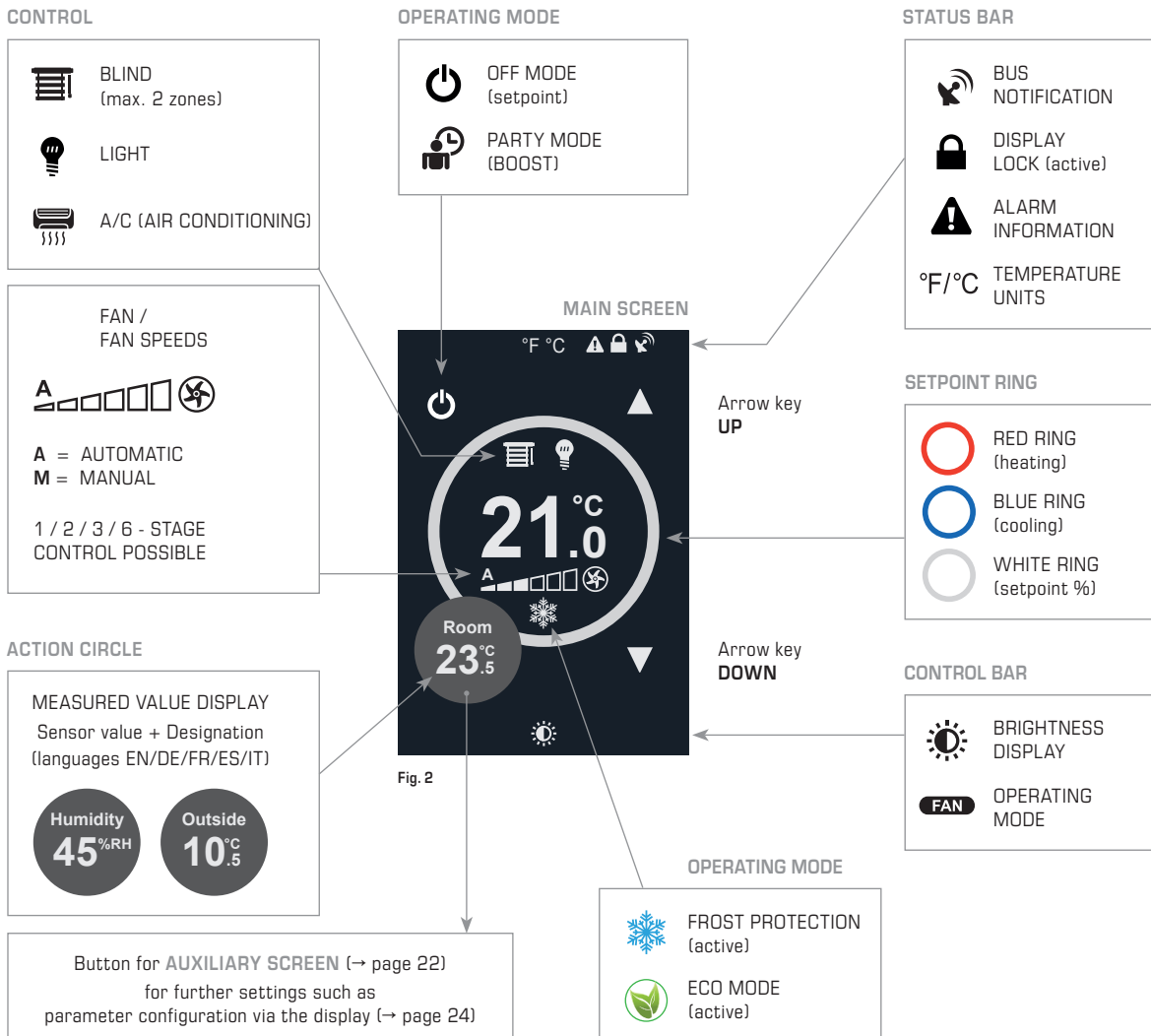

The **main screen** of the room control units has four touch-sensitive areas for changing system settings. All parameter values are provided as Modbus or BACnet variables.

- Arrow keys **UP ▲** and **DOWN ▼** to change the current setpoint (temperature/percentage).
- Small **action circle** for displaying the measured temperature, the CO<sub>2</sub> and moisture content of the air and as a button for accessing the auxiliary screen.
- Function-based switching icon, in **Party Mode** (boost) shows the Party icon and in **OFF Mode** the OFF icon, with which the respective mode can be activated and aborted.
- **Fan** icon and fan line bar for displaying and changing the fan speed in up to 7 fan stages (Auto-1-2-3-4-5-6), if enabled.
- The **ECO** icon and the **Frost protection** icon are displayed under the fan speed when active.
- **A/C (air conditioning)** icon for activation/deactivation of the A/C (air conditioning) control if enabled.
- **Light** icon for activation/deactivation of the room lighting if enabled.
- **Blind** icon as a button for access to the blind screen for controlling the blind (OPEN/CLOSE) and the angle of inclination of the blinds).

## SETPOINT TEMPERATURE

Display options and setpoint adaptation

The large **setpoint ring** of the **main screen** in the unit shows the setpoint temperature with a default setting in degrees Celsius or Fahrenheit.

The display can be changed so that the setpoint value that is relevant for controlling the output power is displayed as a percentage.

### Setpoint Mode:

- **Temperature** (Fig. 3a)  
setpoint temperature display in °C or °F
- **Percent** (Fig. 3b)  
setpoint display in percent
- **None** (Fig. 3c)  
Instead of the setpoint temperature, the circle displays the measured value of sensor 3. If no other measured value is displayed in the action circle, the gearwheel icon for making settings appears instead of the action circle as an indication to call up the secondary screen.
- **Relative** (Fig. 3d)  
Display of the relative target temperature adjustment (+/-)  
**NOTE:** The Setpoint Limit Mode must also be set to 'Relative' under Control Settings.
- **State Select** (Fig. 3e/3f)  
Changing the setpoint in whole numbers,  
display of '**Min.**' or '**Max.**' when the minimum or maximum value is reached

### Target Setpoint

The user can use the **UP** and **DOWN** arrow keys to adjust the setpoint.

The upper and lower thresholds can be adjusted in the settings.

The current setpoint can be accessed via the bus.

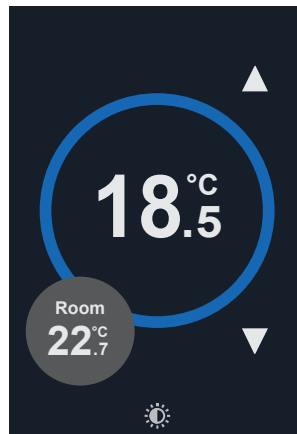

Fig. 3a Temperature display

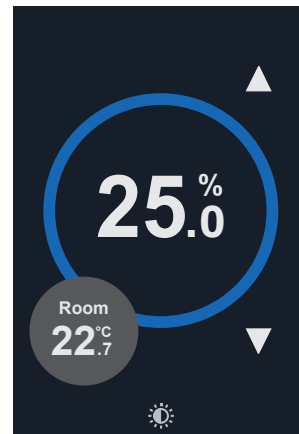

Fig. 3b Display percent



Fig. 3c No display

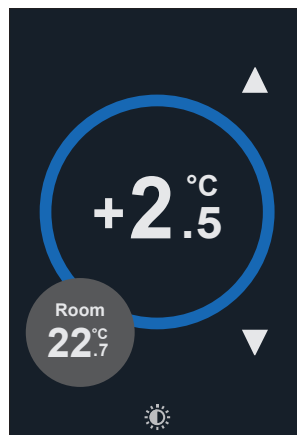

Fig. 3d Display relative

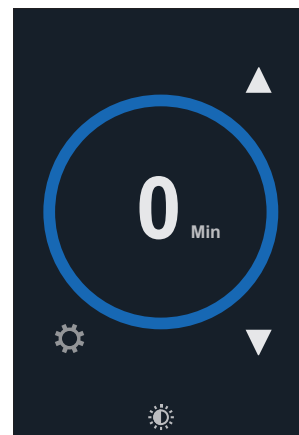

Fig. 3e Mode State Select Min.

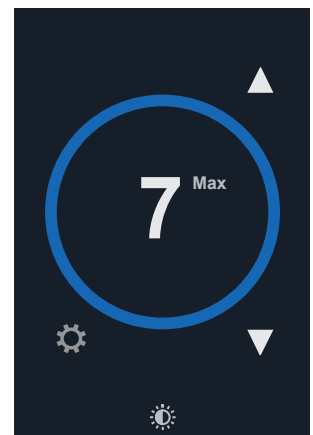

Fig. 3f Mode State Select Max.

## TEMPERATURE MEASUREMENT

Sensor assignment and designations of the temperature zone

The room control units can display up to three temperatures in the grey action circle (sensor 1, sensor 2, sensor 3), the relative humidity (RH option) and the CO2 content in the room (CO2 option).

**Sensor 1** and **Sensor 2** can be used to display two external temperature sensors. The values can be read in either via the two inputs RI1 and RI2 (NTC10K) or via the bus (Settings - Inputs & Outputs - Sensor Source - Network/Hardware).

**Sensor 3** shows the temperature of the sensor integrated in the unit (default). Alternatively, a temperature value can be assigned to sensor 3 via the bus.

The **designations** of the temperature zones in the small grey action circle can be adjusted in Setting Mode (Settings - Display - Sensor Text). If 'deactivated' is set at this point, the recorded value is not shown in the display.

The designations are **pre-defined** (room, kitchen, bathroom, bedroom, outside, zone 1/2/3, pool etc.) and are available in the following **languages**: English (EN), German (DE), French (FR), Spanish (ES), Italian (IT).

### NOTE:

If all sensor displays are 'deactivated' the **action circle is hidden** and **no sensor values** are displayed!



## RH OPTION

Determining the relative humidity [% RH] in the room air

Units with an RH option can detect the relative humidity in the room with an accuracy of 2 % using an internal sensor.

The measured value is shown on the display in the small grey action circle.

The RH display is enabled by default and can be deactivated in the configuration settings.

The RH value can be accessed as a variable via the bus.



## CO2 OPTION

Determining the CO2 content [ppm] of the room air

Units with the CO2 option can monitor and measure the CO2 content in the room via an internal sensor.

The measured value is shown on the display in the small grey action circle.

The CO2 display can be disabled in the settings if required.

The CO2 value can be accessed as a variable via the bus.

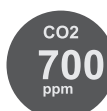

## INPUTS RI1 & RI2

for two external temperature sensors (NTC10K)

An external NTC10k sensor can be connected to each of the inputs RI1 or RI2 for monitoring purposes. The values can be accessed via the bus.

If enabled in the configuration settings (Settings - Inputs & Outputs - Hardware ... and ... Settings - Display - Sensor Text), the value is also shown in the small grey action circle of the display.



### TEMPERATURE UNIT

Selection of degrees Celsius (°C) or degrees Fahrenheit (°F)

#### WARNING!

Changing the default setting for the temperature unit will set the defaults for all other parameters.

Changing the default setting for the temperature unit is intended to be performed as necessary at the start of commissioning.

If the icon for switching between °C /°F is enabled (Settings - Display - Show Unit Swap - Enabled), the temperature displays can be switched between degrees Celsius and Fahrenheit by tapping the icon on the main screen.

This option is especially useful for applications in hotels etc. with international guests.

You can also determine which temperature unit (°C /°F) is set as the default value on the unit in the settings (Systems, Native Units).

If the unit default setting is changed, the unit will reload the factory default settings with the changed unit for all temperature displays.



Fig. 4a Temperature in °C



Fig. 4b Temperature in °F

### SETPOINT RING

Colour selection

The room control units show the setpoint temperature in a large "setpoint ring". The ring colour can be set via the bus or can automatically change its intensity in the Red-Green-Blue spectrum depending on the difference between the set temperature and the temperature measured by sensor 1/2/3.

The following configurations are available:

- 0 = White
- 1 = Red
- 2 = Blue
- 3 = Green
- 4 = Orange
- 5 = Yellow
- 6 = Magenta
- 7 = Cyan
- 8 = Sensor 1
- 9 = Sensor 2
- 10 = Sensor 3 (default)

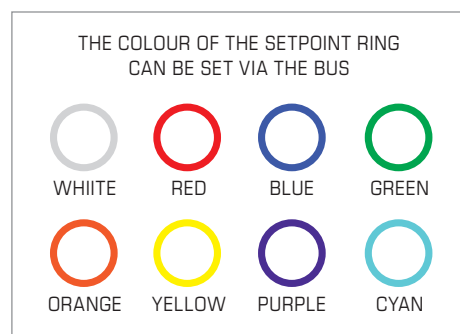

## DIGITAL INPUT DI1

(voltage-free)

The voltage-free digital input can be used to switch on the ECO and OFF/FROST modes with priority or for monitoring purposes only.

Configuration options:

- Close for ECO Mode
- Open for ECO Mode
- Close for OFF Mode
- Open for OFF Mode
- Alarm
- Bus
- Close for night
- Deactivated

Configuration '**Close for**': for example, the voltage-free digital contact can be linked to an external timer to switch the display to OFF or ECO Mode with an input delay.

Configuration '**Open for**': the voltage-free digital input can be used to activate ECO or OFF mode when the contact opens.

In this way, this function is suitable for connecting a window switch or a door card switch.

Configuration '**Alarm**': when the contact closes, the alarm message 'DI contact alarm' appears on the display.

Configuration '**Bus**': suitable if the digital input is to be used for monitoring purposes only.

Configuration '**Close for night**': when the contact closes, the unit switches to Night Mode, in which the setpoint temperature is greyed out and the fan speed is controlled to a pre-set value. At the end of Night Mode, the unit switches back to automatic fan control and the nominal setpoint temperature.

## LANGUAGE SELECTION

Enables language selection  
(EN/DE/FR/ES/IT)

for changing the language on the main and auxiliary screen

Different languages are available for the main and auxiliary screens, which can be set in the system configuration (Settings - System - Language).

The operator of the room control unit can also be enabled for selecting the language. To this end, a switching icon can be enabled in the settings as an abbreviation at the bottom left-hand edge of the **main screen** for the active language (Settings - System - Show Language Swap) (Fig. 5a).

Tapping the abbreviation displays the available languages, and the operator can directly change the language via the screen. (Fig. 5b)

### NOTE:

If the operating mode icon **AUTO/HEAT/COOL/FAN** is active at the bottom left of the display (FIG. 10), the language abbreviation is not available.

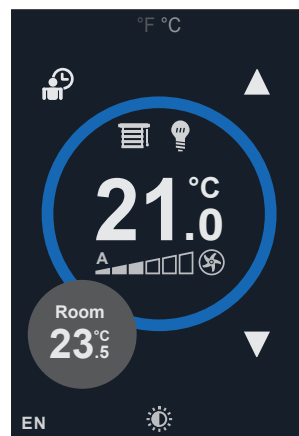

**Fig. 5a** Language abbreviation (opens by tapping the selection of the language options)

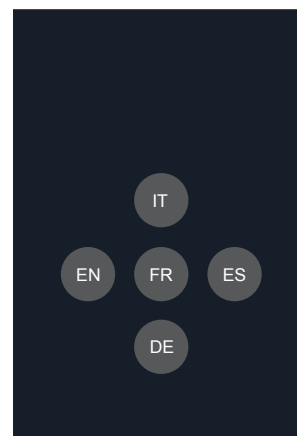

**Fig. 5b** Language options

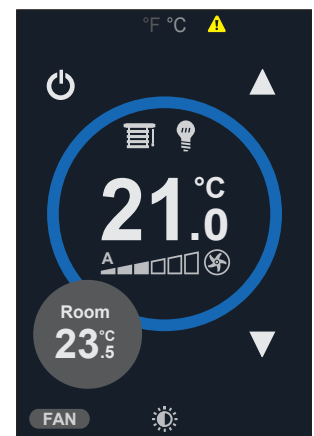

**Fig. 10** Active operating mode (language abbreviation not available)

## FAN SYMBOLS

Fan icon and line bar chart  
 (fan speeds)

**COLOUR LINE BAR**

A = AUTO  
 M = MANUAL

TAPPING THE ICON  
 ENABLES MANUAL  
 SETTING

THE FAN ICON ROTATES  
 (STAGES 1-6) WHEN THE  
 FAN IS ACTIVE

MAIN SCREEN



**AUTO CONTROL**  
 AUTOMATIC CONTROL (A = AUTO)  
 SELECTABLE VIA BUS OR ON THE UNIT.

Speed 0

Speed 1

Speed 2

Speed 3

Speed 4

Speed 5

Speed 6

1 STEP + AUTO MANUAL CONTROL	3 STEP + AUTO MANUAL CONTROL	6 STEP + AUTO MANUAL CONTROL
Speed 0	Speed 0	Speed 0
Speed 1	Speed 1	Speed 1
	Speed 2	Speed 2
	Speed 3	Speed 3
<b>2 STEP + AUTO MANUAL CONTROL</b>	AUTO *	Speed 4
Speed 0		Speed 5
Speed 1		Speed 6
		AUTO *

\* CONTROL VIA BUS:  
 UNIT SWITCHES TO 'AUTO',  
 AS SOON AS A NEW SPEED  
 IS PRESCRIBED VIA THE BUS.

## FAN CONTROL

Display fan speeds  
 and operating modes

The unit is fitted with a fan icon and a line bar chart to display the fan speed.  
 The **display** is configurable (Settings - Display - Fan Speed Display):

- Deactivated (default)
- Icon and line bar
- Only line bar
- Only icon
- Icon and colour line bar
- Only colour line bar

If the fan is set manually (if enabled) or via the bus to a higher level than OFF (level 0),  
 the **Fan icon** and the current fan speed is displayed with the six segments of the line bar.

The **line bar chart** is displayed uniformly with the Fan icon in grey, or  
 optionally as a **colour line bar** in a green-yellow-red scheme (COLOUR LINE BAR).

The system always follows with the last command to be entered.

If the fan speed is set or changed via the bus, the unit automatically changes to Automatic Mode (AUTO),  
 an 'A' is displayed above the line bar.

With **manual priority switching** the display changes to 'M' or only shows 'A' if a manual switch to  
 Automatic Mode has taken place. Otherwise, only the selected fan speed is displayed.

## FAN CONTROL

Selection of fan speeds  
and operating modes

To change the **fan speed**, touch the display in the area of the fan icon and the line bar chart. You can change the fan speed manually via the bus in deviation from the automatic control and depending on the configuration enabled (parameter setting) as follows:

- Deactivated (default)
- **1 STEP:** OFF or Step 6
- **2 STEP:** OFF, Step 3 and Step 6 in sequence
- **3 STEP:** OFF, Steps 2, 4, and 6 in sequence
- **6 STEP:** OFF, Steps 1 to 6 alternating
- **1 STEP + AUTO:** OFF (M), Step 6 (M) and Auto (A) in sequence;  
When switching to Auto, the display returns to the fan speed set via the bus.
- **2 STEP + AUTO:** OFF (M), Step 3 (M), Step 6 (M) and Auto (A) in sequence;  
When switching to Auto, the display returns to the fan speed set via the bus.
- **3 STEP + AUTO:** OFF (M), Steps 2, 4, 6 (M) and Auto (A) in sequence;  
When switching to Auto, the display returns to the fan speed set via the bus.
- **6 STEP + AUTO:** OFF (M), Steps 1 to 6 (M) and Auto (A) in sequence;  
When switching to Auto, the display returns to the fan speed set via the bus.
- **Extended:** Optional fan setting (see following explanation)

Each time the fan display (fan line bar) is tapped, the function changes to the next fan speed. The updating of the speed specified via the bus is suspended for a short time so that it does not interfere with the manual change.

When selecting extended **manual fan control**, the fan display changes between AUTO (bus value), N (Night) and M1 to M6. The **night fan speed** is specified via Modbus register 135, the AUTO speed with the display 'A' via register 111 and the display of the actual speed via register 134.

**ICONS**

**BLIND**

**LIGHT**

**A/C**

**(AIR CONDITIONING)**

**BLIND**  
(max. 2 zones)

TAPPING THE ICON  
ENABLES MANUAL  
SETTING ON THE  
BLIND SCREEN

**LIGHT ON/OFF**  
(1 zone)

**A/C ON/OFF**  
(AIR CONDITIONING)  
(1 zone)

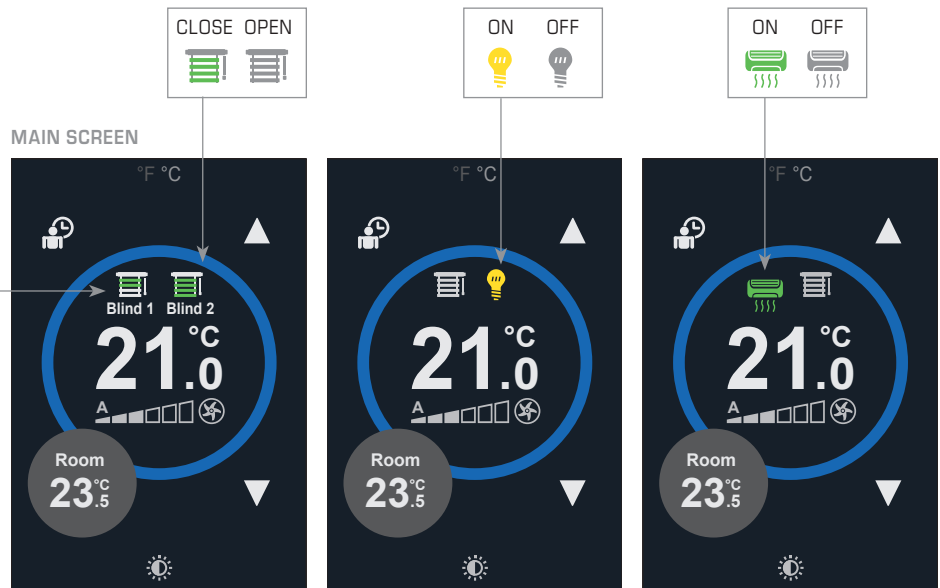

Fig. 6a Blind (2 zones)

Fig. 6b Light (1 zone)

Fig. 6c A/C (air conditioning) (1 zone)

**CONTROL**

**LIGHT**

**A/C**

**(AIR CONDITIONING)**

Display and  
settings  
(1 zone)

The A/C Climate and Light switching icons can be enabled for display on the **main screen** for operating the A/C (air conditioning) and the room lighting.

Tapping the respective icon switches the function ON or OFF.

The status of the switching icons can be accessed and changed via the bus.

The switching icons are enabled in the settings (display, function 1 / 2).

**NOTE:**

Only **1 zone** at a time can be switched for the Light and A/C Climate functions. Configuration for 2 light zones or 2 A/C (air conditioning) zones is not possible.

The Light, A/C Climate and Blind functions share two **icon positions** on the main screen. If both blind zones are enabled, manual control of light and A/C (air conditioning) is not possible.



**BLIND CONTROL**

Display and settings (2 zones)

The  switching icons on the **main screen** can be enabled to operate the blind zones (up to 2 zones). The switching icons are enabled in the settings (display - function 1 / 2).

**NOTE:**

The Light, A/C Climate and Blind functions share two **icon positions** on the main screen. If both blind zones are enabled, manual control of light and A/C (air conditioning) is not possible.

Tapping the respective icon means that the unit changes to the **blind screen**.

Depending on the configuration in the settings menu, an adjustment of the blind can be made on the blind screen via the arrows with different step sizes and types of movement. The step size and movement types can be configured as follows (Settings - Display).

**Blind Mode (step size):**

- 2 Positions (On/Off)
  - 5 Positions (4 steps)
  - 11 Positions (10 steps)
  - Sliding / 1% steps (infinite)
- The positions are distributed equally from 0-100%.

**Blind configuration (movement type, graphical depiction):**

- Translatory movement 'Level' (Fig.7a)
- Rotary movement 'Tilt' (Fig.7b)
- Translatory + rotary movement 'Level + Tilt' (Fig.7c)

**BLIND SCREEN (display options)**

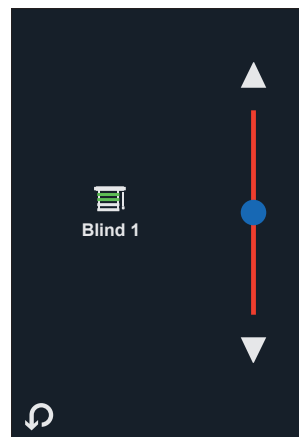

Fig. 7a 'Level'

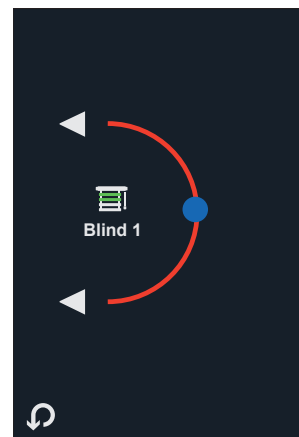

Fig. 7b 'Tilt'

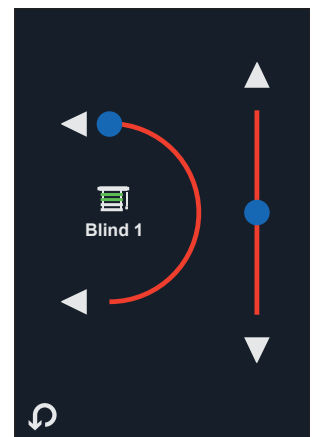

Fig. 7c 'Level + Tilt'

If one of the arrows on the **Blind screen** is tapped for a short time, the corresponding value (0-100%) changes by the set step size. The value (position of the blind) can be accessed and changed via the bus.

If **sliding step size** is set, the control will behave via the display as follows:

- Short tapping of the arrow changes the corresponding value by 1%.
- Touching an arrow for longer than 0.6 s will change the value automatically and the arrow can be released. The automatic change is stopped either by a short tap on the arrow or reaching the min./max. value (0/100 %).

The last command to be issued applies. That means that if the position of the blind has been changed via the bus, the user can change the mode value again and vice versa.

## OFF MODE

Display and setting of OFF Mode

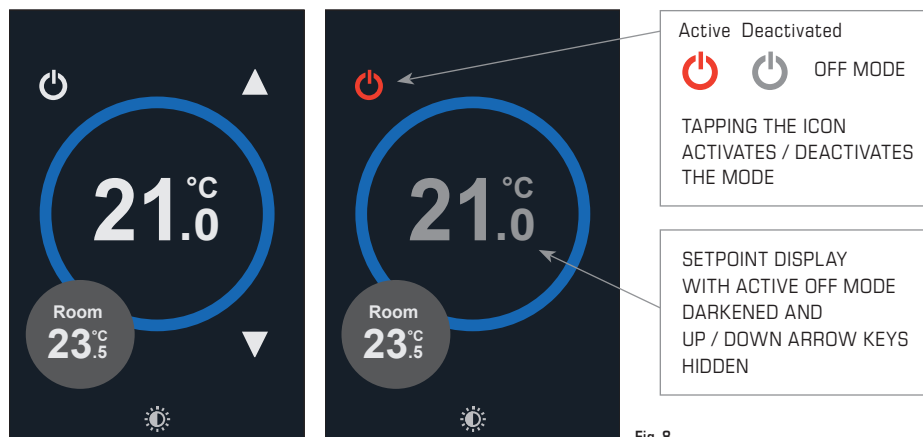

Fig. 8

Depending on the system configuration, the unit can be switched to OFF Mode via the display, the voltage-free digital input (e.g. with an external timer) or the bus.

In OFF Mode, the OFF icon is displayed in red, the setpoint temperature is darkened and the **UP** / **DOWN** arrow keys are hidden.

**NOTE:** If the user wants active functions (such as light and A/C) to be switched off or the blind to move to a certain position when the OFF icon is pressed, this must be carried out by the GLT.

OFF mode can be cancelled by tapping the OFF icon. The system is designed so that the last command always determines the current status. Example: If the unit has been set to OFF Mode by priority switching via the bus or the digital input, the user can cancel OFF mode by tapping the OFF icon. On the other hand, a networked unit which the user has switched to OFF Mode can be switched back to the normal operating mode by the bus master.

### Configuration options for the OFF icon:

- **Not enabled**  
 The switching icon is hidden (default).
- **Enabled**  
 The switching icon is displayed on the main screen.  
 If Party Mode is also activated,  
 the OFF icon is displayed on the auxiliary screen.

## NIGHT MODE

Priority switching for Night Mode via the digital input

The unit can be switched to Night Mode via the digital input.

In Night Mode, the setpoint temperature is darkened (as in OFF Mode, fig.8) and the fan speed is displayed as it has been configured for Night Mode.

At the end of Night Mode, the unit returns to Normal Mode (digital input open) and the Nominal Setpoint is displayed (default 21.0°C).

**PARTY MODE (BOOST)**

Display and setting of PARTY Mode (Boost function)

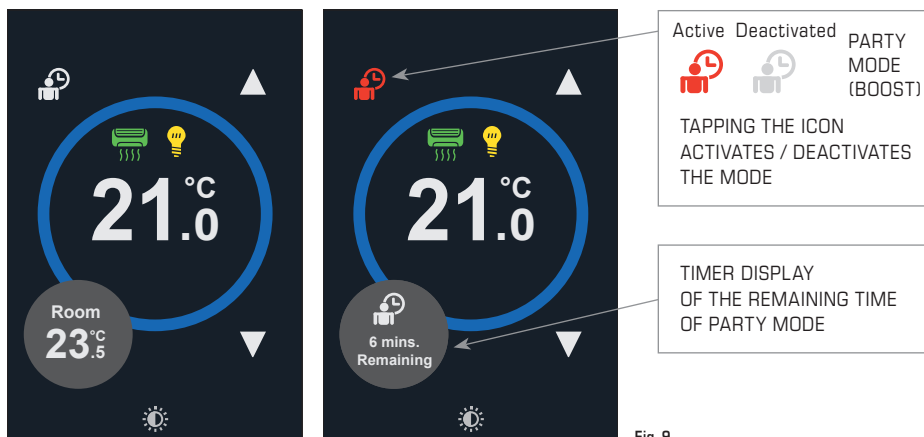

Fig. 9

The unit is fitted with a switching icon for PARTY Mode. If a time period has been set for PARTY mode (BOOST), tapping the PARTY icon starts the mode and the icon will turn red.

In PARTY Mode, the unit activates the internal relay (default) and the status can be accessed via the bus. Tapping the icon again aborts the mode. PARTY Mode can also be activated/deactivated via the bus.

If the relay has been configured on the bus, PARTY Mode has no effect on the relay.

## OPERATING MODE

Display and setting of the operating mode

The unit can display the mode currently set by the user or via the bus at the bottom edge of the display (control bar) with a plain text icon:

- **AUTO** (Automatic Mode)
- **FAN** (Ventilation)
- **HEAT** (Heating)
- **COOL** (Cooling)

These icons are deactivated for the user as a button by default. Display of the current mode is still possible via the bus, without the user being able to change it via the screen.

If enabled for the user (display Mode icon), the mode changes when the icon is tapped. The following configurations are available:

- Deactivated (default)
- **HEAT / COOL**  
(switch between heating/cooling)
- **HEAT / COOL / FAN**  
(switch between heating/cooling/fan)
- **AUTO / HEAT / COOL**  
(switch between auto/heating/cooling)
- **AUTO / HEAT / COOL / FAN**  
(switch between auto/heating/cooling/fan)
- **AUTO / HEAT / FAN**  
(switch between auto/heating/fan)
- **AUTO / COOL / FAN**  
(switch between auto/cooling/fan)

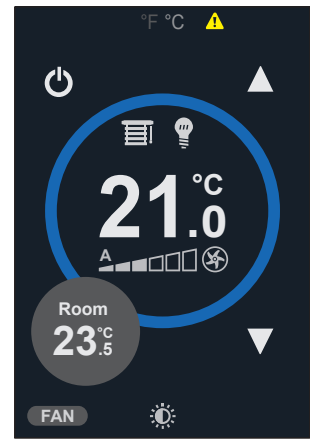

Fig.10

OPERATING MODE  
(active)

**AUTO** = AUTOMATIC  
**FAN** = VENTILATION  
**HEAT** = HEATING  
**COOL** = COOLING

TAPPING THE ICON  
 CHANGES THE MODE  
 IN THE CONFIGURED  
 SEQUENCE.

(Default = mode deactivated!)

**ECO MODE**

Display and setting of the ECO Mode

The unit can be switched to ECO Mode via the bus or the digital input. The ECO icon is shown in the display (if enabled).

Tap on the Eco icon in the main screen to abort ECO Mode.

The last command applies, i.e. if the controller was switched to ECO via the bus or the digital input, the user can cancel the mode by tapping the ECO icon.

**NOTE:**

The display of the ECO icon can be deactivated in the settings (Display - Disable ECO button). When deactivated, the mode cannot be cancelled by the user.

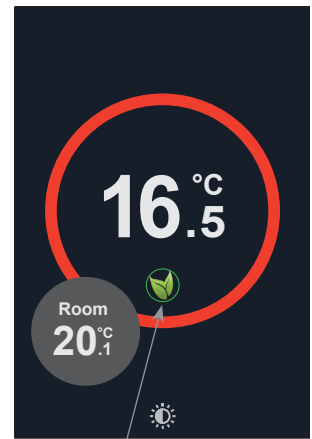
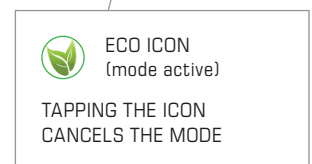

Fig.11



**FROST MODE**

Displaying Frost Mode

The FROST PROTECTION icon can be activated via the bus, to display Frost Mode (defrosting).

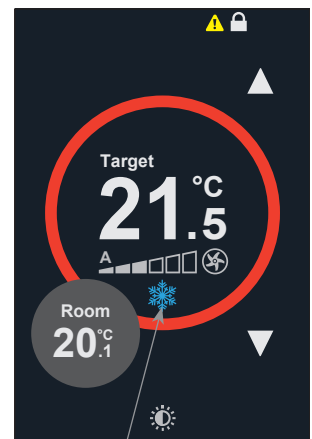
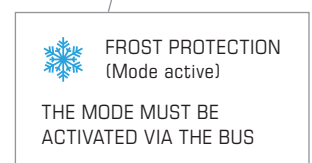
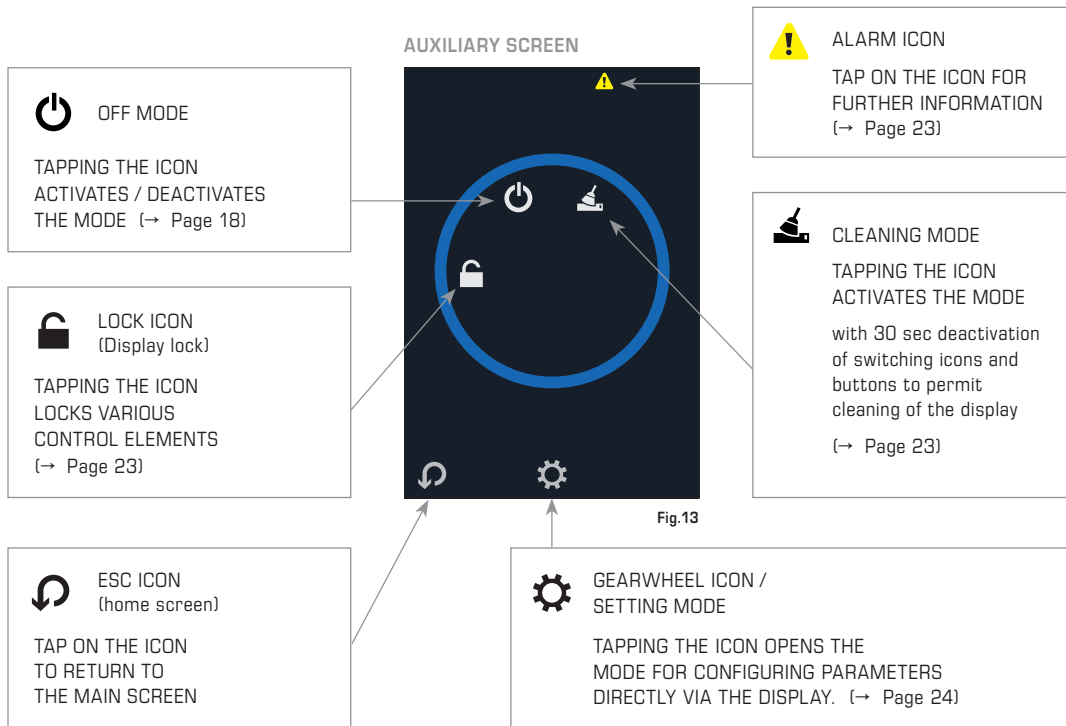

Fig.12



**AUXILIARY SCREEN  
 ICONS**



**AUXILIARY SCREEN**

Other operating icons  
 and information

The **auxiliary screen** can be accessed by touching the small grey action circle on the main screen.

Access to the auxiliary screen can be protected by a **PIN** code  
 ('Staff Code', default: 0000 = no PIN required).

### ALARM DISPLAY

Accessing the alarm notifications

Warnings on the unit can be accessed by tapping the Alarm icon on the **auxiliary screen**.

**NOTE:**

If 'Bus' is set as the sensor source, the alarm will be suppressed.

Typical causes of an alarm notification.

- **External sensor 1 (RI1) error**  
(if activated but not connected)
- **External sensor 2 (RI2) error**  
(if activated but not connected)
- **Integrated sensor error**
- **Digital contact error**

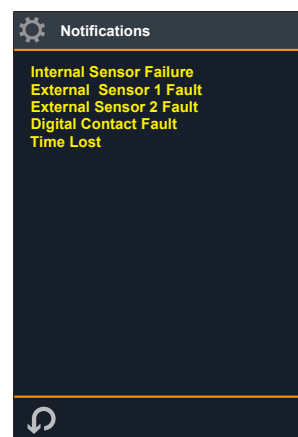

Fig.14

### CLEANING MODE

Activating Cleaning Mode (cleaning the display)

Cleaning mode can be activated by tapping the Cleaning icon on the **auxiliary screen**.

The unit changes to the 'display cleaning' state, all switching icons and buttons are disabled and a 30 second timer is displayed.

The display can be cleaned during this time without causing any unintentional entries.

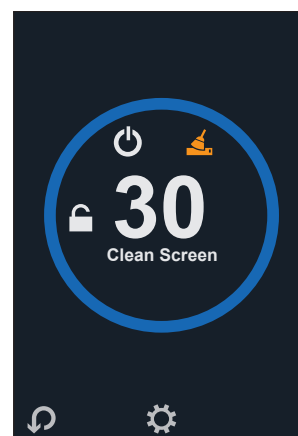

Fig.15

### LOCK MODE

Activate the display lock

Tapping the lock icon on the **auxiliary screen**, makes it possible to lock the unit to prevent unauthorized access.

A **PIN** code can be defined to activate/deactivate the locking state ('Lock Code', default: 0000 = no PIN required).

**NOTE:**

The display lock is also retained if the unit is switched off and back on again.

The following configurations are available (see table).

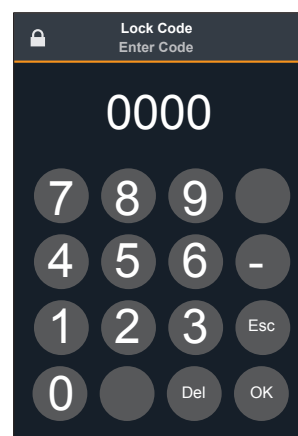



Fig.16

LOCK MODE	ACTIVE SWITCHING ICONS							
			PARTY / OFF MODE	ECO MODE	FAN	AIR CON AC	LIGHT	BLIND
Deactivated	–	●	●	●	●	●	●	●
Only ON / OFF	●	–	●	–	–	●	●	●
Only adjustment	●	●	–	–	●	–	–	●
No input	●	–	–	–	–	–	–	●

**CONFIGURING THE PARAMETERS**

Setting Mode  
 for changing parameters  
 directly on the display

Tapping the cogwheel icon  on the **auxiliary screen** activates setting mode in order to configure accessible parameters directly on the display.

Access requires entry of a **PIN** code ('Maintenance Code', default: 6666).

**NOTE:**

The PIN code can be changed in the settings (System - Maintenance Code).  
 Note the new PIN for security.

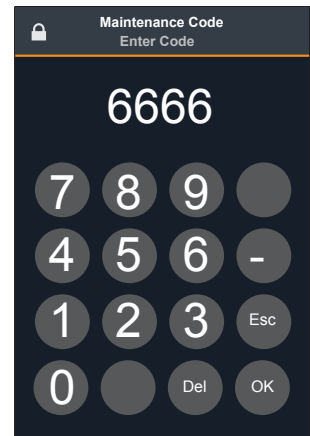

Fig.17

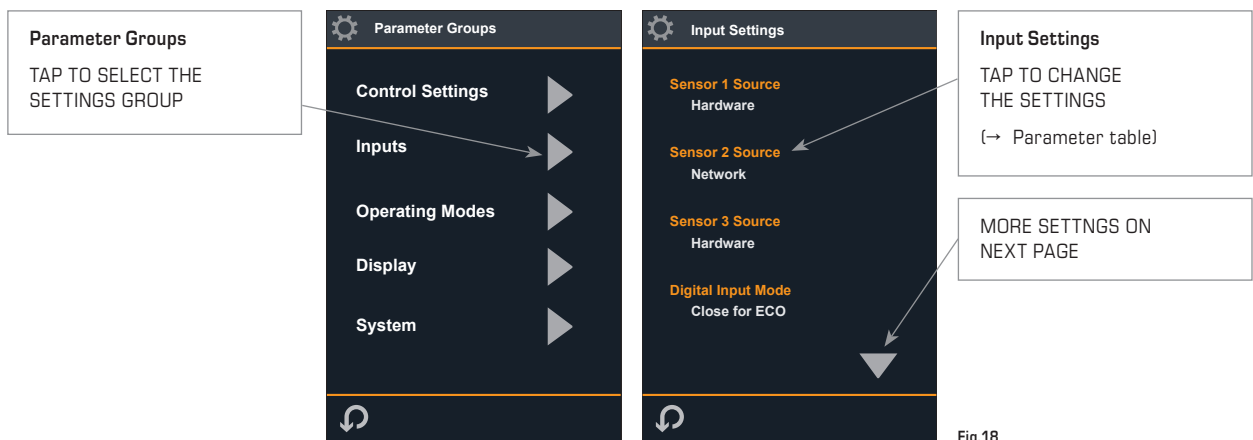

Fig.18

After successfully entering the PIN Code, the 'Parameter Groups' **'Parameter Groups'** are displayed. Tapping the arrow key accesses the list of the subordinate **'Input Settings'**. The plain text here acts as a button for entry of the parameter settings. For description and input area, **see parameter table** on the following pages!

**NOTE:**

Changed communication parameters are activated when setting mode is exited – the unit performs a soft reset. Alternatively, the new settings can also be activated by switching the unit off and on again.

**Saving the parameters**

The configuration parameters are stored in the non-volatile memory of the unit. After changing the configuration via the display, the new parameters are saved when the unit returns to the main screen.

If the changes were made via the bus (Modbus), the parameter for updating the non-volatile memory is required in order to force saving.

If configuration takes place via the display, the parameters are saved after an expiry time or when the settings menu is closed.



**PARAMETER TABLE**

Setting Mode via unit screen

<b>CONTROL SETTINGS</b>		
<b>Parameter name</b>	<b>Description</b>	<b>Area</b>
Nominal Setpoint	Nominal setpoint	0.0...95.0 °C/°F/% (default 21.0 °C)
Setpoint Limit Mode	Type of setpoint limitation	0 = Absolute (Default) 1 = Relative
Min. Setpoint Adj	Absolute: smallest adjustable lower limit Relative: maximum permissible setpoint downwards adaptation	0.0...95.0 °C/°F/% (default 14.0)
Max. Setpoint Adj	Absolute: highest adjustable upper limit Relative: maximum permissible setpoint upwards adaptation	0.0...95.0 °C/°F/% (default 30.0)

<b>INPUTS &amp; OUTPUTS</b>		
<b>Parameter name</b>	<b>Description</b>	<b>Area</b>
Sensor 1 Source	If set to hardware, input RI1 (NTC10k) is read. If set to network, the value can be transmitted to the unit via the bus.	0 = Hardware (RI1) 1 = Network (default)
Sensor 2 Source	If set to hardware, input RI2 (NTC10k) is read. If set to network, the value can be transmitted to the unit via the bus.	0 = Hardware (RI2) 1 = Network (default)
Sensor 3 Source	If set to hardware, the internal temperature sensor is read. If set to network, the value can be transmitted to the unit via the bus.	0 = Hardware (internal sensor, default) 1 = Network
Digital Input Mode	Setting the function of digital input DI (status monitoring via the bus active in all cases). For explanations see chapter " <i>Voltage-free digital input DI1</i> "	0 = Disabled 1 = Close for ECO (default) 2 = Open for ECO 3 = Close for OFF 4 = Open for OFF 5 = DI Contact Alarm 6 = Network 7 = Close for Night
Digital Input Delay	Digital input delay (when changing over from active to inactive)	0...7200 s (default 0 s)
Internal Sensor Cal.	Single-point calibration of internal sensor	-10.0...+10.0 °C/°F
RI1 Cal.	Calibration of sensor connected to RI1	-10.0...+10.0 °C/°F
RI2 Cal.	Calibration of sensor connected to RI2	-10.0...+10.0 °C/°F
Hum Cal.	Calibration of internal RH sensor (devices with RH option)	-10.0...+10.0 % RH
CO2 Cal.	Calibration of CO2 sensor (devices with CO2 option)	-500...+500 ppm
Y1 mode	Not active/settable	
Y2 mode	Not active/settable	
Y3 mode	Not active/settable	
AO temp. scale	Not active/settable	
AO CO2. Scale	Not active/settable	
Fan Night Speed	Fan speed during night operation (OFF mode)	0...6 (default 0)
AO SP Min	Not active/settable	
AO SP Max	Not active/settable	

OPERATING MODES		
Parameter name	Description	Area
Lock Mode	Enable of lock icon for display locking. Selection of which functions are to be locked on the display (display llock) (0) Disabled: No display lock icon (1) On/Off Only: Icon for display lock displayed/active, temperature adjustment and deactivation of ECO mode not possible (2) Adjust Only: Icon for display lock displayed/active, only temperature and sun protection adjustment possible (3) No Input: Icon for display lock displayed/active, only sun protection adjustment possible	0 = Disabled (Default) 1 = On/Off Only 2 = Adjust Only 3 = No Input
Lock Code	PIN for activation/deactivation of display lock (0000: no PIN required)	0000...9999 (default 0000)
Relay Mode	Setting of the relay function NO/NC: linked with Party mode (Boost) Network: controlled via the bus	0 = Control NO (default) 1 = Control NC 2 = Network
Fan Manual Control	Setting of fan mode / fan speeds <b>NOTE:</b> For parameters 1-9 the display of the fan speed must be activated (display, fan speed display)	0 = Disabled (Default) 1 = 1-step 2 = 2- step 3 = 3- step 4 = 6- step 5 = 1- step +Auto 6 = 2- step + Auto 7 = 3- step + Auto 8 = 6- step + Auto 9 = Advanced
Party Mode (Boost) Time	Boost mode run time 0: Disabled / Deactivated	0...480 min (default 0)
Ring Colours	Setting of the colour of the large ring on the display 8-10: The ring colour changes its intensity in the red-green-blue spectrum automatically depending on the difference between the target temperature and the temperature recorded by sensor 1/2/3.	0 = White 1 = Red 2 = Blue 3 = Green 4 = Orange 5 = Yellow 6 = Magenta 7 = Cyan 8 = Sensor 1 9 = Sensor 2 10 = Sensor 3 (Default)

<b>DISPLAY</b>		
<b>Parameter name</b>	<b>Description</b>	<b>Area</b>
Brightness	Display lighting in standby	0...20 (default 5)
Enable Function 1	Enable of icon for A/C (air conditioning) or blind 1 and the relevant variables for manual control via the bus. If blind 1 has been selected, blind 1 mode must be adapted/monitored at the same time.	0 = Disabled (Default) 1 = A/C 2 = Blind 1
Enable Function 2	Enable of the icon for lights or blind 2 and the relevant variables for manual control via the bus. If blind 2 has been selected, blind 2 mode must be adapted/monitored at the same time.	0 = disabled (Default) 1 = Lights 2 = Blind 2
Fan Speed Display	Enable of the fan icon and/or the fan speeds (Bar) and the relevant variables for manual control via the bus. <b>NOTE:</b> For parameters 1-5 the number of fan speeds must be set (Operating Modes, Fan Manual Control)	0 = Disabled (Default) 1 = Bar & Fan 2 = Bar 3 = Fan 4 = Coloured Bar & Fan 5 = Coloured Bar
Blind 1 Mode	Setting of the step width for blind 1 when pressing the arrow keys on the screen. (1) On/Off: 0, 100 % (2) 4 steps: 0, 25, 50, 75, 100 % (3) 10 steps: 0, 10, 20, ..., 100 % (4) infinite: 0, 1, 2, 3, ..., 100 % Parameter 4 activates an automatic system which automatically changes the value using a long keypress (see description "Blind Control")	1 = On/Off 2 = 4 steps 3 = 10 steps 4 = infinite
Blind 1 Configuration	Enable of graphical display of movement type of the blind and the relevant variables for manual control via the bus. (0) Level: translatory movement, UP/DOWN (1) Tilt: rotatory movement, rotation (2) Level + Tilt	0 = Level 1 = Tilt 2 = Level + Tilt
Blind 2 Mode	Setting of the step width for blind 1 when pressing the arrow keys on the screen. (1) On/Off: 0, 100 % (2) 4 steps: 0, 25, 50, 75, 100 % (3) 10 steps: 0, 10, 20, ..., 100 % (4) infinite: 0, 1, 2, 3, ..., 100 % Parameter 4 activates an automatic system which automatically changes the value using a long keypress (see description "Blind Control")	1 = On/Off 2 = 4 steps 3 = 10 steps 4 = infinite
Blind 2 Configuration	Enable of graphical display of movement type of the blind and the relevant variables for manual control via the bus. (0) Level: translatory movement, UP/DOWN (1) Tilt: rotatory movement, rotation (2) Level + Tilt	0 = Level 1 = Tilt 2 = Level + Tilt

Mode Icon	Enable and selection of the plain text button for the operating mode Auto: Auto Htg: Heizen Clg: Kühlen Fan: Lüften	0 = Disable (Default) 1 = Htg/Clg 2 = Htg/Clg/Fan 3 = Auto/Htg/Clg 4 = Auto/Htg/Clg/Fan 5 = Auto/Htg/Fan 6 = Auto/Clg/Fan
Off Icon	Enable of the Off icon	0 = Disabled (Default) 1 = Enabled
Humidity Display	Enable of the RH display (devices with RH option) The value is displayed in the small action circle.	0 = Disabled 1 = Enabled (Default)
CO2 Display	Enable of CO2 display (devices with CO2 option) The value is displayed in the small action circle.	0 = Disabled 1 = Enabled (Default)
Show Unit Swap	Enable of icon for switching between degrees Celsius and degrees Fahrenheit on the main screen	0 = Disabled (Default) 1 = Enabled
Sensor 1 text	Designation of sensor 1 (RI1/network) Default 0 = Disabled <b>NOTE:</b> If disabled, no text and measurement is displayed for sensor 1.	0 = Disabled 1 = Room 2 = Floor 3 = Outside
Sensor 2 text	Designation of sensor 2 (RI2/network) Default 0 = Disabled <b>NOTE:</b> If disabled, no text and measurement is displayed for sensor 2.	4 = Zone 1 5 = Zone 2 6 = Zone 3 7 = Bathroom
Sensor 3 text	Designation of sensor 3 (internal/network) Default 1 = Room <b>NOTE:</b> If disabled, no text and measurement is displayed for sensor 3.	8 = Sauna 9 = Bedroom 10 = Kitchen 11 = Cooler 12 = Flow 13 = Hot Water 14 = Tank 15 = Pool 16 = Cabin
Setpoint Mode	(0) Temperature: Target temperature display in °C or °F (1) Percentage: Setpoint display in percent (2) None: The measurement of sensor 3 is displayed in the circle instead of the target temperature. If no other measurement is displayed in the action circle, instead of the action circle a gearwheel is displayed as suggestion to call up the secondary screen. (3) Temperature Rel.: Display of the relative target temperature adaptation (+/-) The Setpoint Limit Mode must be set to Relative (4) State Select: Change to setpoint in whole numbers, display of "Min"/"Max" if minimum/maximum value reached	0 = Temperature (Default) 1 = Percentage 2 = None 3 = Temperature Rel. 4 = State Select
Disable ECO-Button	Enable of ECO icon for user-side cancellation of ECO mode	

SYSTEM		
Parameter name	Description	Area
Address	Setting of bus address for Modbus devices Setting of MAC address for BACnet devices	Modbus: 0...247 (default 1) BACnet: 0...127 (default 1)
Baud rate	Baud rate for Modbus or BACnet devices	0 = 9600 (default) 1 = 19200 2 = 38400 3 = 57600 4 = 76800 5 = 115200
Parity	Parity for Modbus or BACnet devices Odd: odd Even: even	0 = None (default) 1 = Odd 2 = Even
Stop Bits	Stop bits for Modbus or BACnet devices	0 = 1 Stop-Bit (Default) 1 = 2 Stop-Bits
Device ID	Device ID (for BACnet devices only) (0: Auto)	0...4.194.303 (Default 0 = Auto = 651.001)
Service-Pin	BACnet service pin (only for BACnet devices, if active the controller transmits a BACnet 'I-am' notification)	0 = Disabled (Default) 1 = Enabled
Maintenance Code	PIN for setting mode (0000: no PIN required)	0000...9999 (default 6666)
Staff Code	PIN for access to secondary screen (0000: no PIN required)	0000...9999 (default 0000)
Language	Available languages for the user interface (Main screen)	0 = DE (Default) 1 = EN 2 = FR 3 = ES 4 = IT
Show Language Swap	Display of switching icon (code) for selecting the operating language on the main screen	0 = Disabled (Default) 1 = Enabled
Screen Refresh-Rate	Refresh rate of the LCD touch screen	0 = Fast 1 = Medium 2 = Slow (Default)
Native Units (defaults) °C/°F presetting	Default value of temperature displays in degrees Celsius or degrees Fahrenheit <b>NOTE:</b> Change leads to reloading of the default values	C = Celsius (default) F = Fahrenheit
Reload Defaults	Reload factory settings (defaults)	0 = Off (Default) 1 = On
Version	Software version	x.xx (BACnet/Modbus)



© Copyright by S+S Regeltechnik GmbH

Reprint in full or in parts requires permission from S+S Regeltechnik GmbH.

Subject to errors and technical changes. All statements and data herein represent our best knowledge at date of publication. They are only meant to inform about our products and their application potential, but do not imply any warranty as to certain product characteristics. Since the devices are used under a wide range of different conditions and loads beyond our control, their particular suitability must be verified by each customer and/or end user themselves. Existing property rights must be observed. We warrant the faultless quality of our products as stated in our General Terms and Conditions.