

**In-ceiling motion sensor
with switching output**

The in-ceiling motion sensor and presence detector **KINASGARD® DBWF / DBWF-C** detects the presence of persons and movements and has a switching contact as an output. It has been designed for monitoring and detecting statuses and for motion-dependent control of room functions, e.g. for lowering the temperature of unused rooms.

The in-ceiling motion sensor is used for installation in suspended ceilings in corridors, offices, as well as in residential and business facilities. The connecting head is pluggable for quick, easy mounting. The measuring transducer is accommodated in a separate housing. The sensor detects motions over an aperture angle of 110° and a perimeter of 360°. The patented lens system with 20 individual lenses results in only very small dark areas that are only a few centimetres wide even at a distance of 10 m, thereby reliably detecting small movements.

**DBWF
DBWF-C**
connecting head,
pluggable



TECHNICAL DATA

Power supply:	24 V AC (± 20 %); 15...36 V DC
Power consumption:	< 1 W at 24 V DC; < 2 VA at 24 V AC
Sensor:	infra-red motion sensor (see beginning of this chapter)
Detection range:	perimeter 360°, aperture angle 90° / 110°, reach approx. 10 m, circular, at an installation height of approx. 3 m the sensor covers a detection radius (r) of approx. 3.4 m
Motion detection:	of persons and objects, necessary temperature difference between subject and surroundings ≥ 5 K
After-running time:	adjustable from 4 seconds to 16 minutes
Ambient temperature:	-10...+50 °C
Connecting head:	plastic, material polycarbonate (PC), colour white, pluggable
Connecting cable:	PVC, LiYY, 4 x 0.14 mm ² , cable length (KL) = approx. 2 m
Electrical connection:	0.14 - 1.5 mm ² via terminal screws
Mounting (sensor):	in the suspended ceiling, ceiling cutout Ø = 30 mm, cover Ø = < 35 mm
Protection type (sensor):	IP 30 (according to EN 60 529) in the built-in state
Protection class (sensor):	III (according to EN 60 730)
Standards:	CE-conformity, electromagnetic compatibility according to EN 61 326, EMC Directive 2014 / 30 / EU

DBWF measuring transducer

Output:	potential-free changeover contact (24 V), 1 A ohmic load
Housing:	plastic, UV-resistant, material polyamide, 30% glass-globe reinforced, with quick-locking screws (slotted / Phillips head combination), colour traffic white (similar to RAL 9016)
Housing dimensions:	72 x 64 x 37.8 mm (Tyr 1)
Cable connection:	cable gland , plastic (M 16 x 1.5; with strain relief, exchangeable, inner diameter 10.4 mm) or M12 connector according to DIN EN 61076-2-101 (optional on request)
Protection type (housing):	IP 67 (according to EN 60 529) housing tested, TÜV SÜD, report no. 713139052 (Tyr 1)

DBWF-C measuring transducer

Output:	potential-free normally open contact , signal relay, max. 24 V / 0.5 A
Housing:	plastic, material PVC, colour black
Housing dimensions:	55 x 20 x 15 mm (compact form)
Protection type (housing):	IP 20 (according to EN 60 529) (compact form)

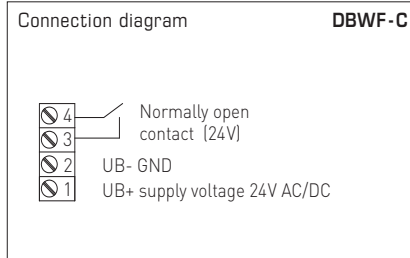
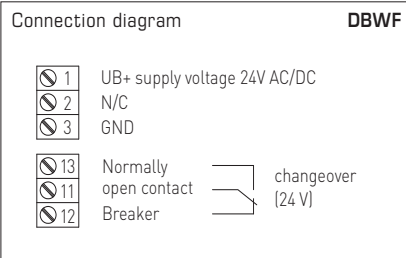
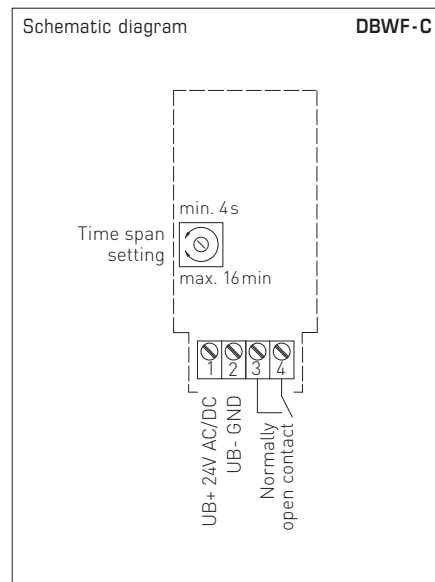
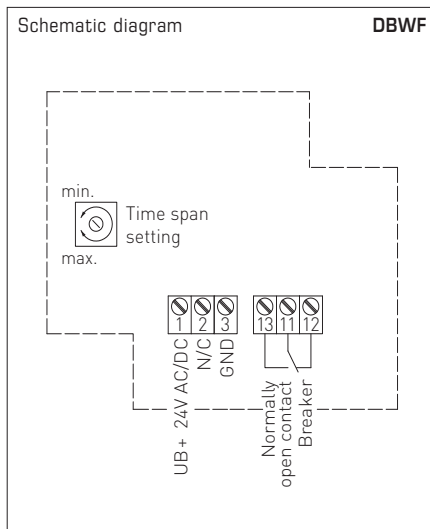

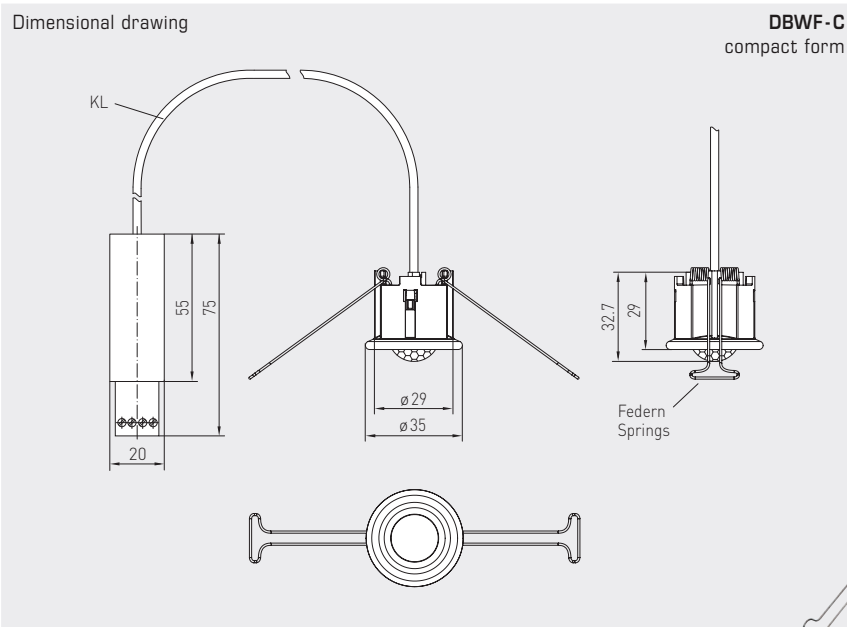
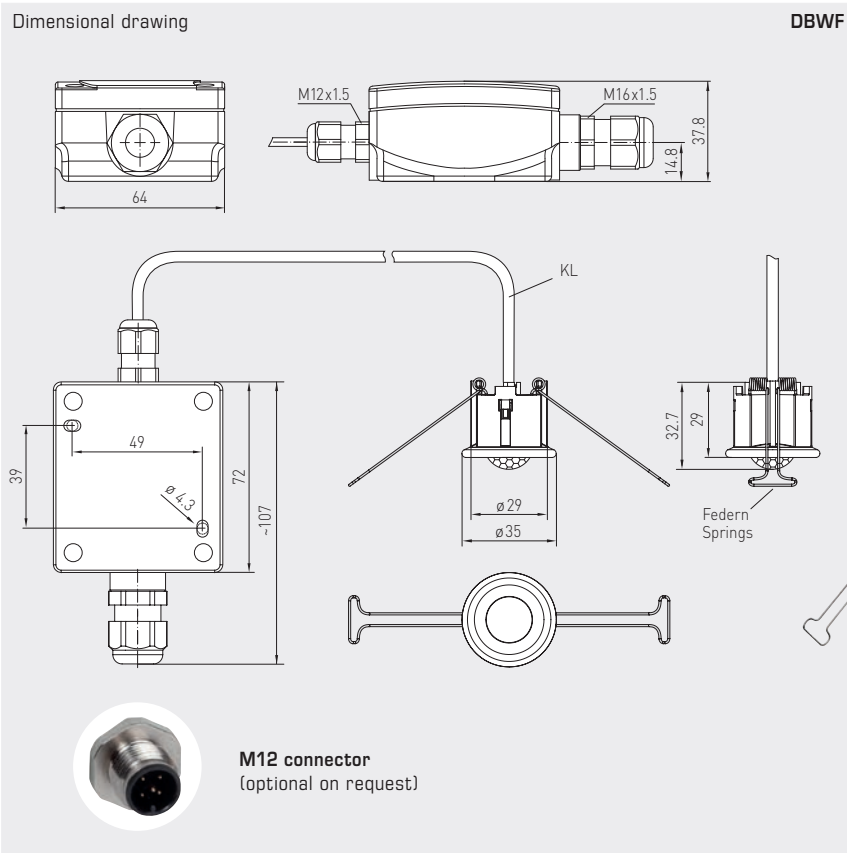

Type / WG01	Detection	Output	Item no.	Price
KINASGARD® DBWF	In-ceiling motion sensor			
KINASGARD® DBWF-C	In-ceiling motion sensor, compact form			
	Presence + Movement	Presence + Movement		
DBWF				
DBWF-W	Yes / No (relay on / off)	Changeover contact	1401-6120-3000-000	139,06 €
Optional:	Cable connection with M12 connector according to DIN EN 61076-2-101		on request	
DBWF-C				
DBWF-C	Yes / No (relay on / off)	Normally open contact	1401-6130-1000-006	103,98 €