

KWR系列是非隔离型调压模块，调节电位器150K/2W，220K/2W，470K/2W。由于其具备多种应用的性能，是最广泛使用的工业调压模块。输出电流为10~100A。

- ◆ 负载电流范围10A~100A
- ◆ 调节电位器150K/2W,220K/2W,470K/2W
- ◆ 带有安全保护盖(可选)
- ◆ LED指示
- ◆ 内置RC吸收回路



产品选型 ▶

KWR	240	F	40	-L
KWR系列	负载电压 240:240VAC 380:380VAC 480:480VAC	调节电位器档位 F:150K/2W G:220K/2W H:470K/2W	负载电流 10: 10Amp 25: 25Amp 40: 40Amp 60: 60Amp 80: 80Amp 100: 100Amp	L: LED 指示灯

技术参数 ▶

输入参数		
调节电位器档位	F	150K/2W
	G	220K/2W
	H	470K/2W

技术参数 ▶

输出参数		
输出电源电压范围	240VAC	24-280VAC
	380VAC	24-440VAC
	480VAC	24-530VAC
最大浪涌电流(@10ms)	10A	100A
	25A	250A
	40A	400A
	60A	600A
	80A	800A
	100A	1000A
最大瞬态电压	240VAC	600Vpk
	380VAC	800Vpk
	480VAC	1200Vpk
最大断态漏电流 (在额定电压下)		5mA

其它参数		
介质耐压 (50Hz/60Hz)	输入,输出/底板	2500Vrms
绝缘电阻 (@500VDC)		1000MΩ
工作温度范围		-30°C ~ +80°C
储存温度范围		-30°C ~ +100°C
重量[典型值]	10A/25A/40A/60A/80A	90g
	100A	150g

应用场合 ▶

各种温度调节装置、塑料成型机械、硫化机械等

安装尺寸图 ▶

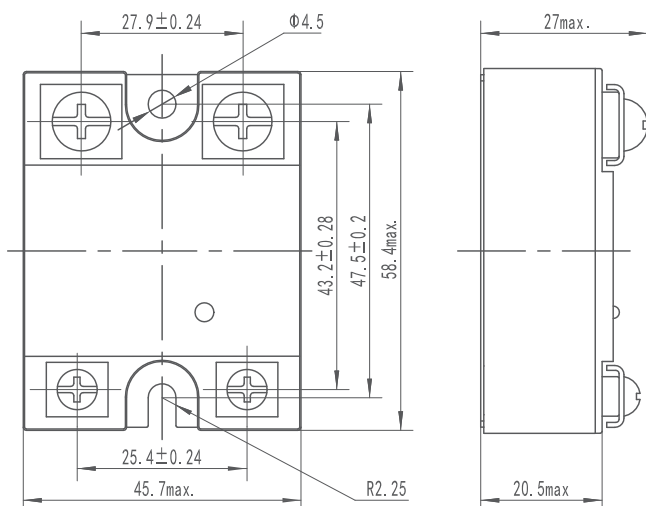

接线图 ▶

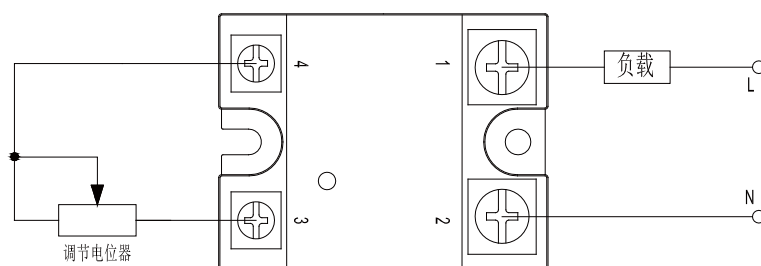

调节电位器阻值与电压输出有效值曲线图 ▶

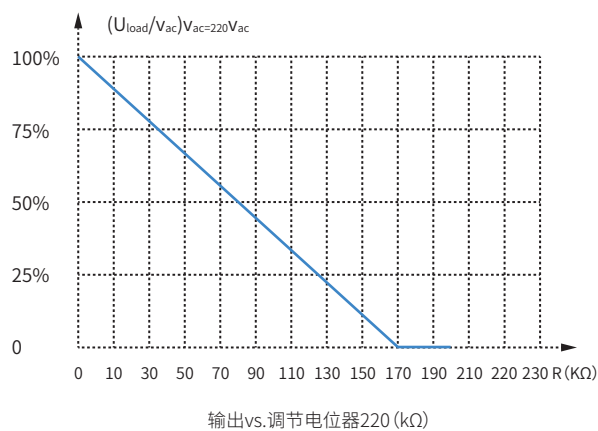
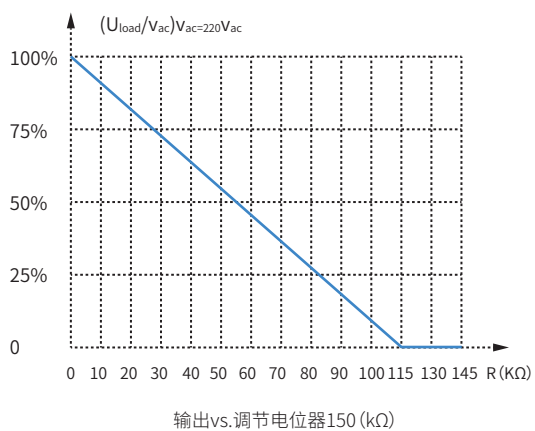

调节电位器阻值与电压输出有效值曲线图 ▶

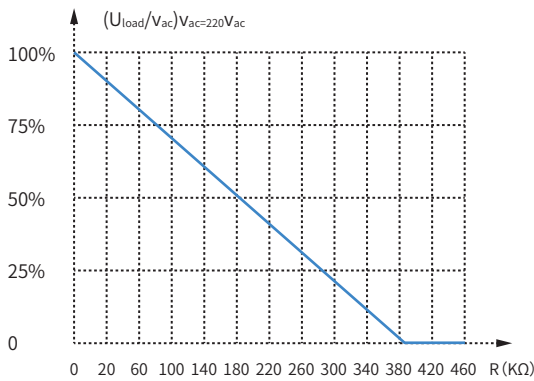

输出vs.调节电位器470 (kΩ)

温度曲线 ▶

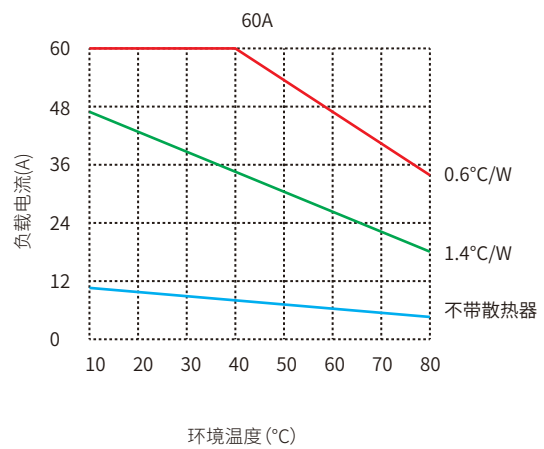
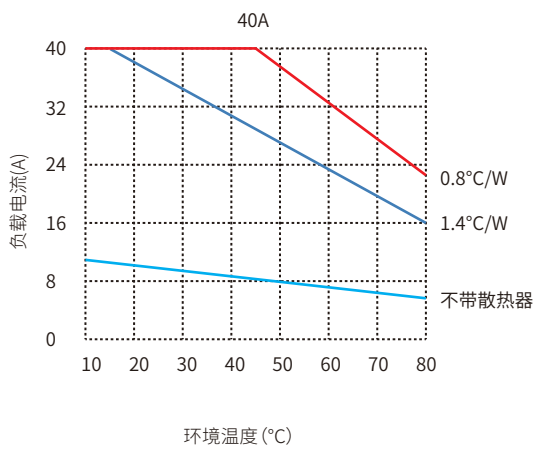
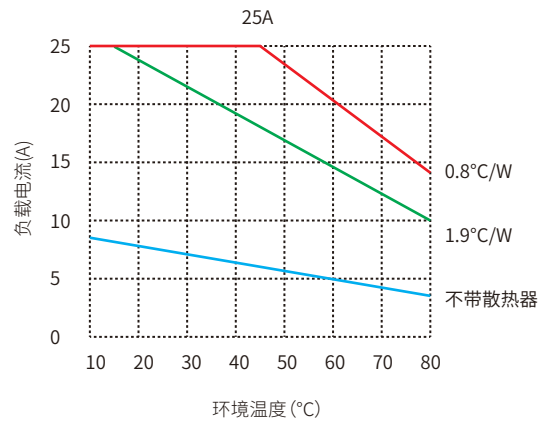
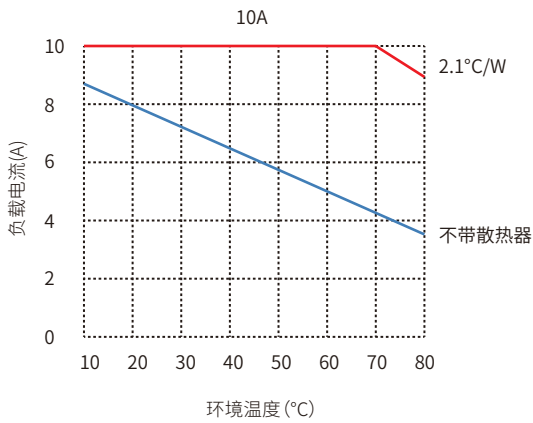

温度曲线 ▶

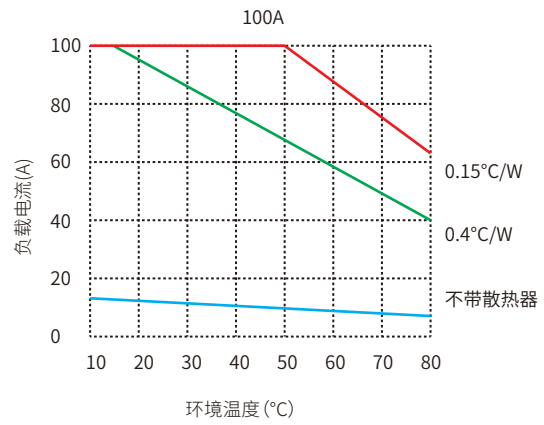
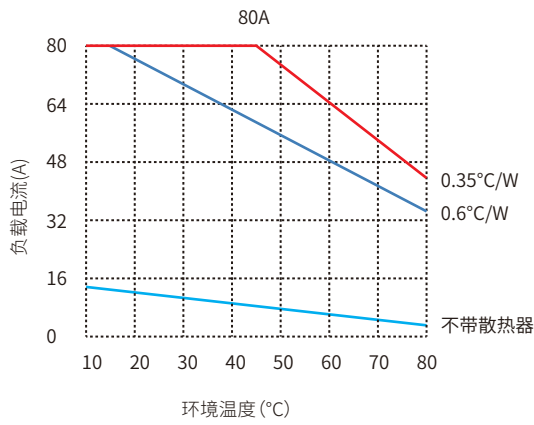

注意事项 ▶

1. 调压模块工作产生的热量需通过底板散出, 需确保调压模块底板与散热器接触紧密、安装牢靠, 且接触面需加导热垫片或涂覆导热硅脂。
2. 调压模块端子应确保接线牢固, 接线松弛会导致产品异常发热, 损坏产品。M3端子的推荐安装扭矩为 (0.58~0.98) N·m, M4端子的推荐安装扭矩为 (0.98~1.37) N·m。
3. 产品工作的环境温度较高时, 请参照温度曲线降额使用。

产品认证 ▶

